

Curve series

**TL44-S-15W**

optical lens



Technical Parameters:

Name	Parameters
Light source:	COB
Input Voltage:	AC220~240V 50/60Hz
LED Current:	350mA, 35-37V
Beam Angle:	12°/24°/36°/60°
Life Time:	> 50,000h - L80 - B10 (Ta 25° C)
Operating temperature:	-20°C~40°C
Certificate:	CE/RoHS
Weight:	0.35kg

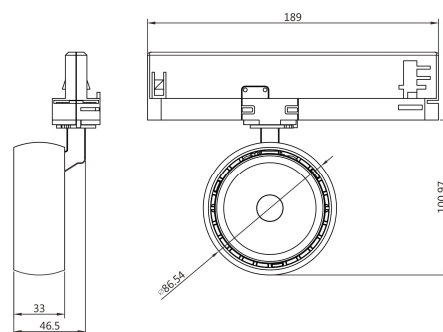

Ordering Information:

○ White ● Black

Power	CRI	Beam Angle	Luminous	CCT	Housing	Part Number
15W	>80	▲ 12°	1500 lm	3000K	○	TL44*-15W-830-W-12-S
					●	TL44*-15W-830-B-12-S
		▲ 24°	1600 lm	4000K	○	TL44*-15W-840-W-12-S
					●	TL44*-15W-840-B-12-S
		▲ 36°	1480 lm	3000K	○	TL44*-15W-830-W-24-S
					●	TL44*-15W-830-B-24-S
	>90	▲ 12°	1580 lm	4000K	○	TL44*-15W-840-W-24-S
					●	TL44*-15W-840-B-24-S
		▲ 20°	1520 lm	3000K	○	TL44*-15W-830-W-36-S
					●	TL44*-15W-830-B-36-S
		▲ 36°	1650 lm	4000K	○	TL44*-15W-840-W-36-S
					●	TL44*-15W-840-B-36-S
	>80	▲ 12°	1270 lm	3000K	○	TL44*-15W-930-W-12-S
					●	TL44*-15W-930-B-12-S
		▲ 24°	1370 lm	4000K	○	TL44*-15W-940-W-12-S
					●	TL44*-15W-940-B-12-S
		▲ 36°	1260 lm	3000K	○	TL44*-15W-930-W-24-S
					●	TL44*-15W-930-B-24-S
	>90	▲ 12°	1350 lm	4000K	○	TL44*-15W-940-W-24-S
					●	TL44*-15W-940-B-24-S
		▲ 20°	1320 lm	3000K	○	TL44*-15W-930-W-36-S
					●	TL44*-15W-930-B-36-S
		▲ 36°	1420 lm	4000K	○	TL44*-15W-940-W-36-S
					●	TL44*-15W-940-B-36-S

\*: 4: 3 Phase 4 wires European Track, 6: 3 Phase 6 wires European Dali track

Technical Data test pattern

CRI80 12°

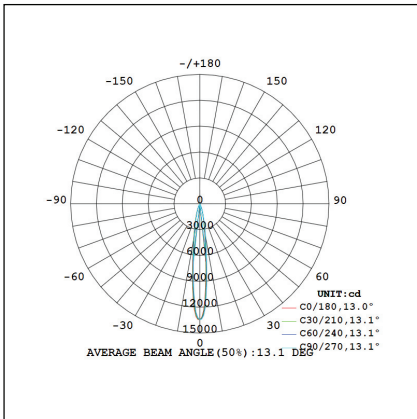

3000K

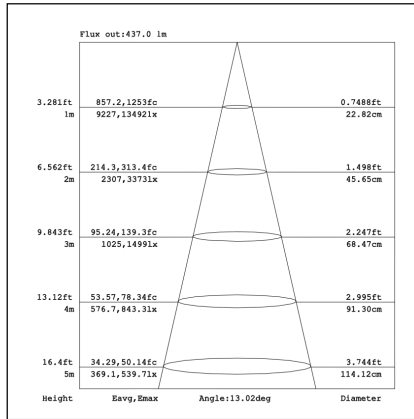

4000K

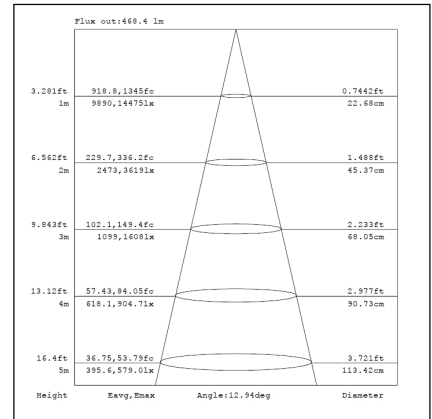

CRI80 24°

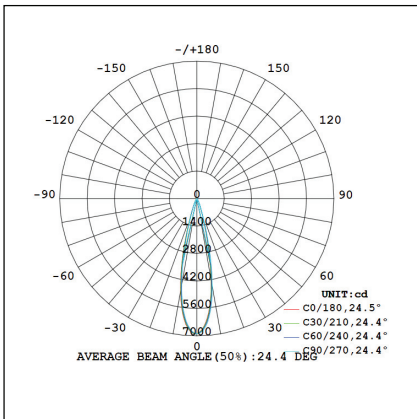

3000K

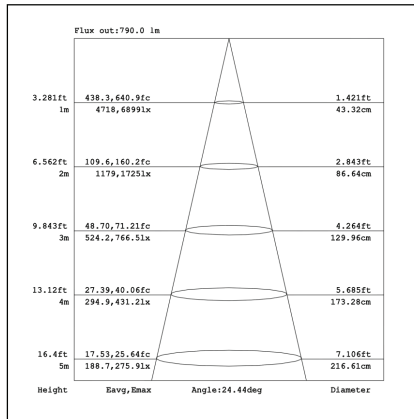

4000K

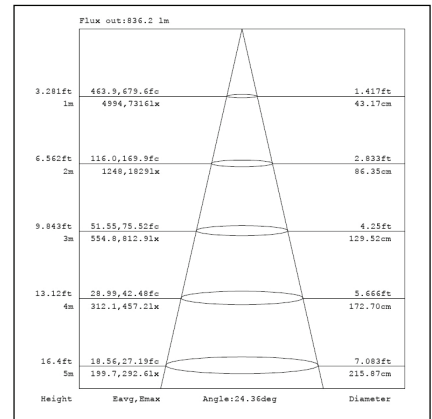

CRI80 36°

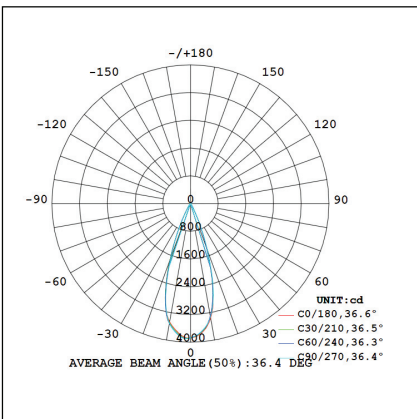

3000K

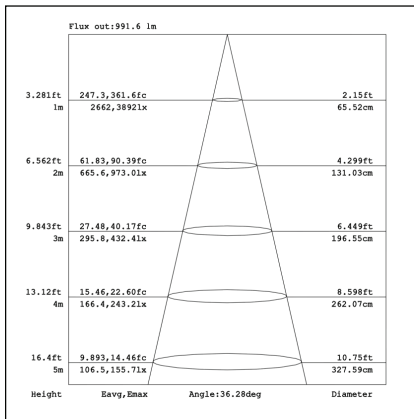

4000K

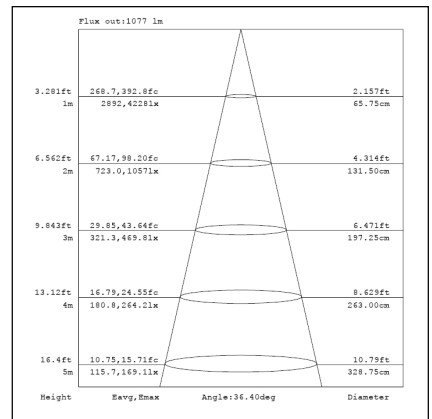

CRI90 12°

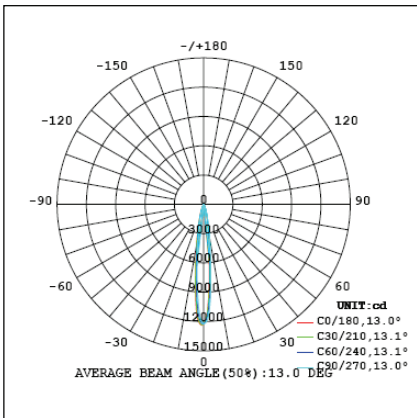

3000K

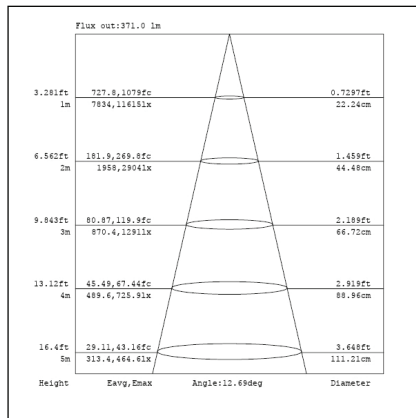

4000K

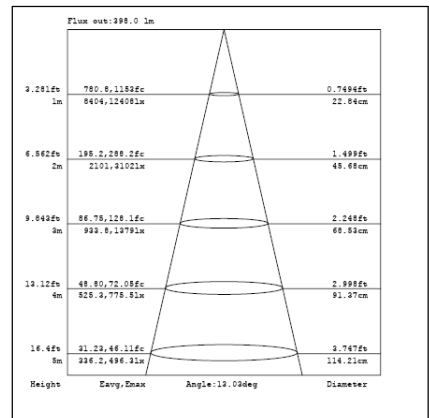

CRI90 24°

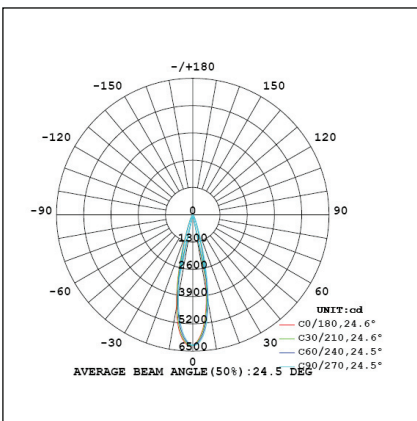

3000K

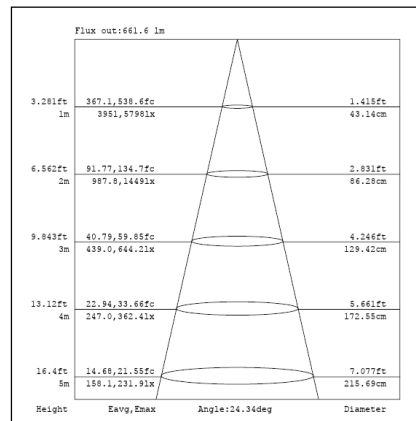

4000K

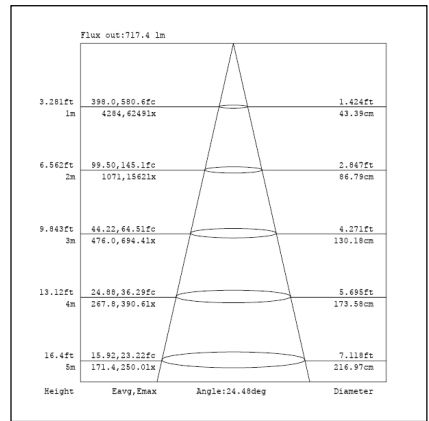

CRI90 36°

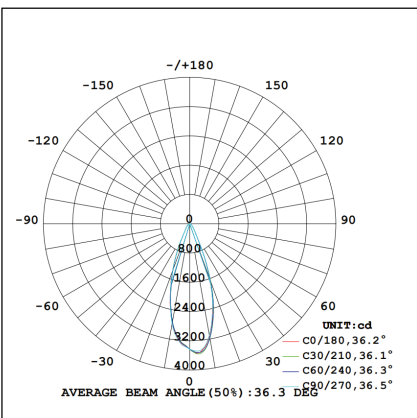

3000K

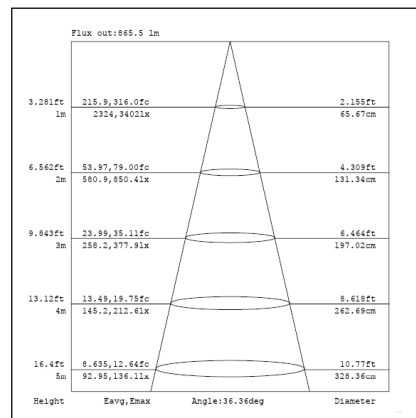

4000K

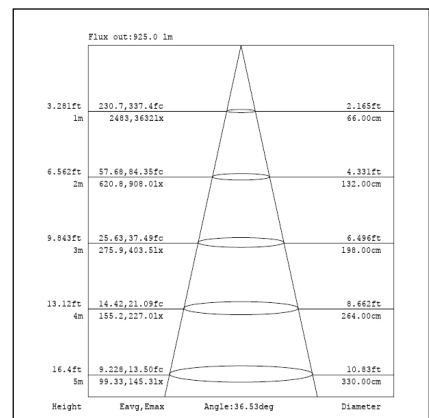

# TL44 Tacklight Installation Instructions

## Adaptor installation diagram

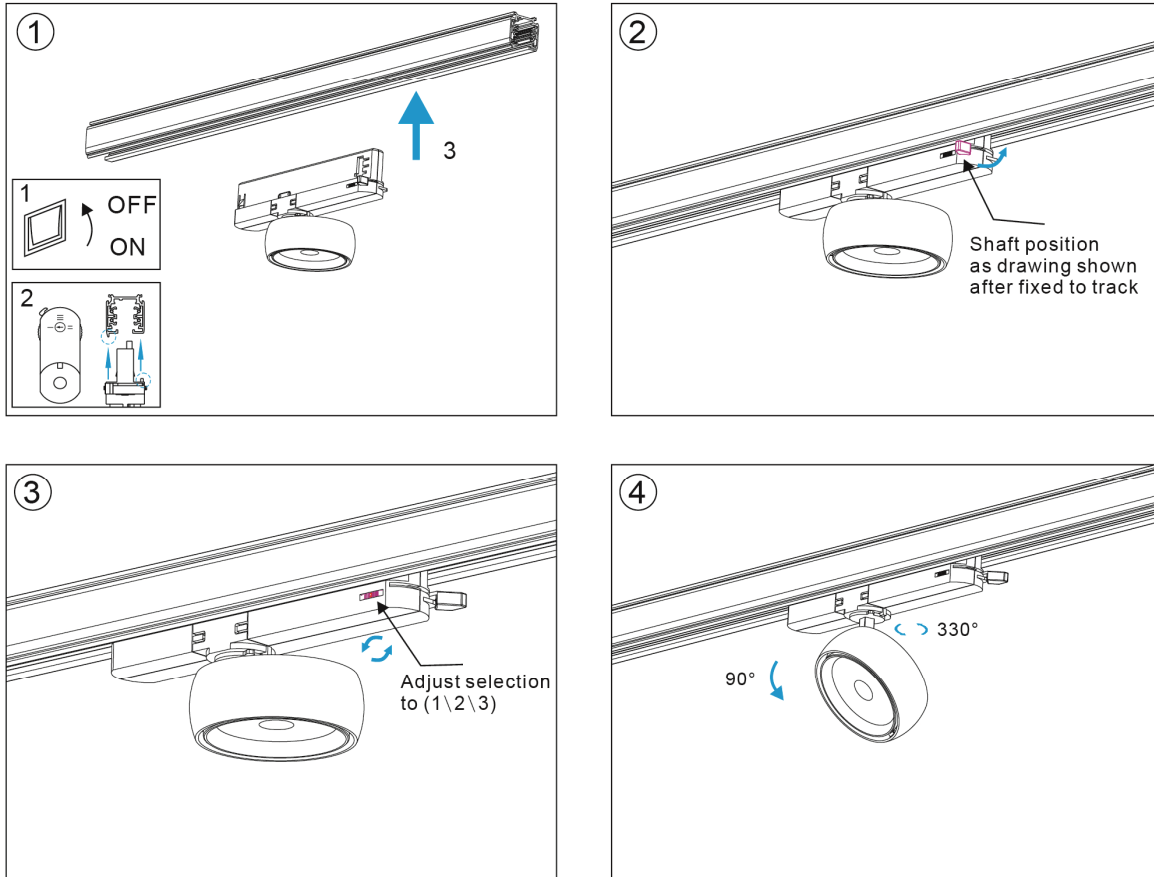

### Packaging:

#### TL44-S

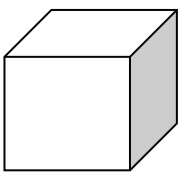

**Box**

L250\*W165\*H64mm  
 1pc/box  
 GW: 0.4kg/box

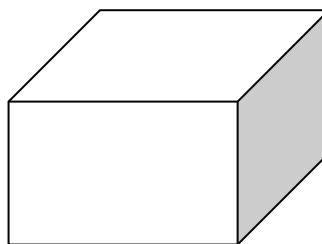

**Outer carton**

L520\*W350\*H350mm  
 20pcs/CTN  
 GW: 9.2kg/carton