

iTrack TEC Series

TL15-40W

Reflector



Technical Parameters:

Name	Parameters
Light source:	COB
Input Voltage:	AC220~240V 50/60Hz
LED Current:	1000mA, 35-37V
Rated life:	>50,000 hours
Operating temperature:	-20℃~40℃
Storage temperature:	-30℃~60℃
Certificate:	TUV/CE/RoHS
Weight:	1.75KG

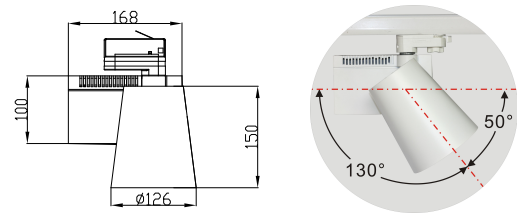

Ordering Information:

○ White ● Black

Power	CRI	Beam Angle	Luminous	CCT	Housing	Part Number
40W	>80	▲ 12°	4140 lm	3000K	○	TL154-40W-830-W-12
					●	TL154-40W-830-B-12
		4420 lm	4000K	○	TL154-40W-840-W-12	
				●	TL154-40W-840-B-12	
		▲ 20°	4180 lm	3000K	○	TL154-40W-830-W-20
					●	TL154-40W-830-B-20
	4350 lm	4000K	○	TL154-40W-840-W-20		
			●	TL154-40W-840-B-20		
	▲ 45°	4030 lm	3000K	○	TL154-40W-830-W-45	
				●	TL154-40W-830-B-45	
	4140 lm	4000K	○	TL154-40W-840-W-45		
			●	TL154-40W-840-B-45		
>90	▲ 12°	3530 lm	3000K	○	TL154-40W-930-W-12	
				●	TL154-40W-930-B-12	
	3700 lm	4000K	○	TL154-40W-940-W-12		
			●	TL154-40W-940-B-12		
	▲ 20°	3550 lm	3000K	○	TL154-40W-930-W-20	
				●	TL154-40W-930-B-20	
3740 lm	4000K	○	TL154-40W-940-W-20			
		●	TL154-40W-940-B-20			
▲ 45°	3400 lm	3000K	○	TL154-40W-930-W-45		
			●	TL154-40W-930-B-45		
3650 lm	4000K	○	TL154-40W-940-W-45			
		●	TL154-40W-940-B-45			

Technical Data test pattern

CRI80 12°

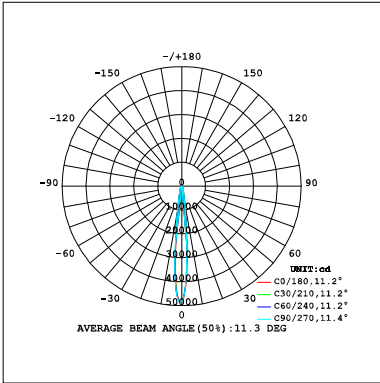

3000K

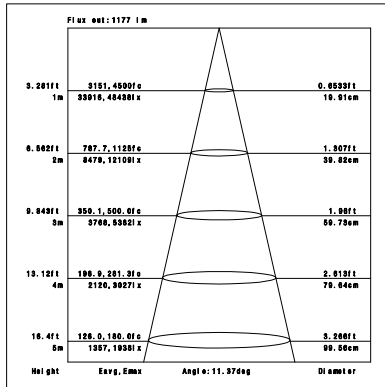

4000K

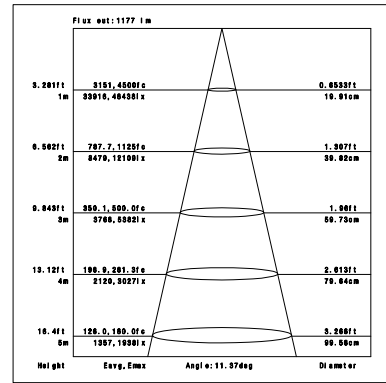

CRI80 20°

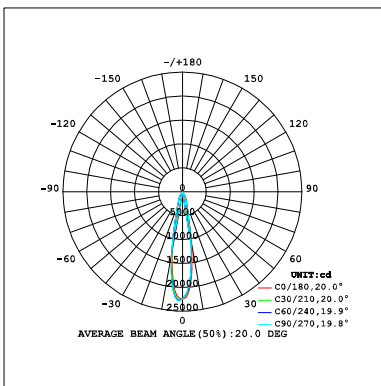

3000K

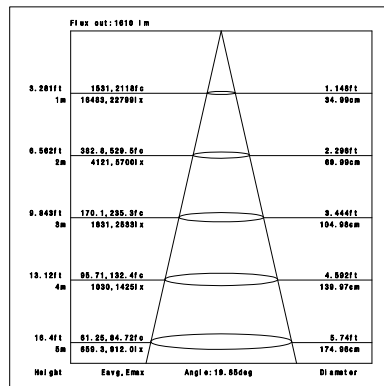

4000K

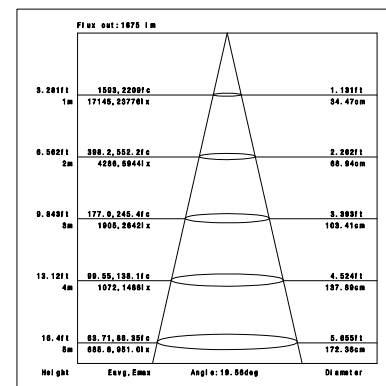

CRI80 45°

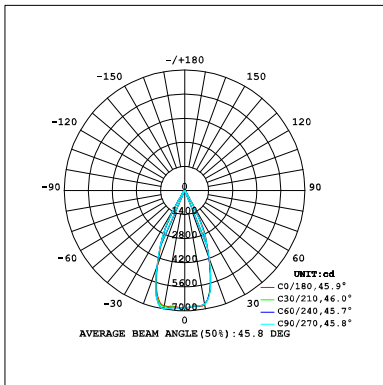

3000K

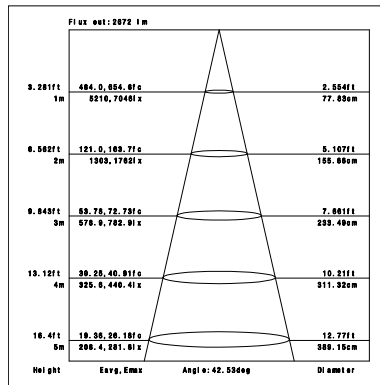

4000K

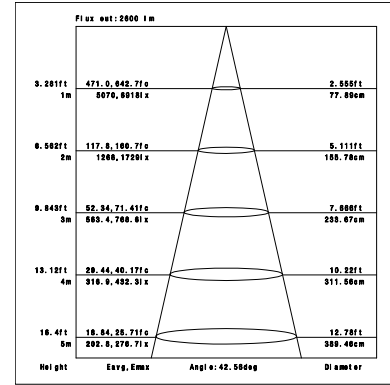

CRI90 12°

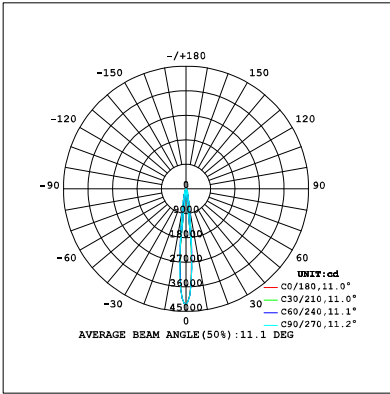

3000K

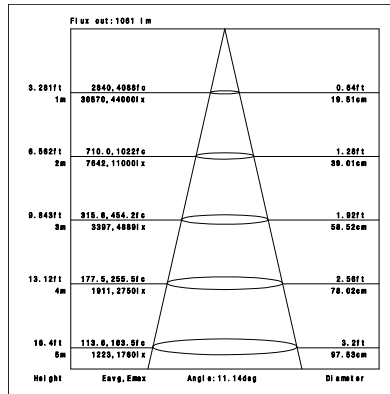

4000K

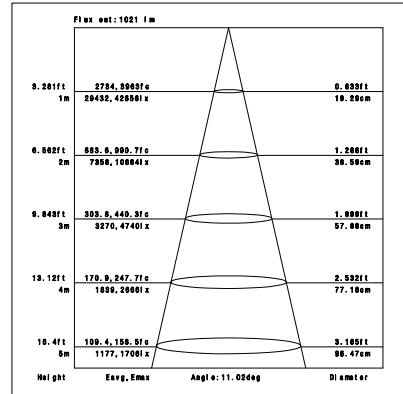

CRI90 20°

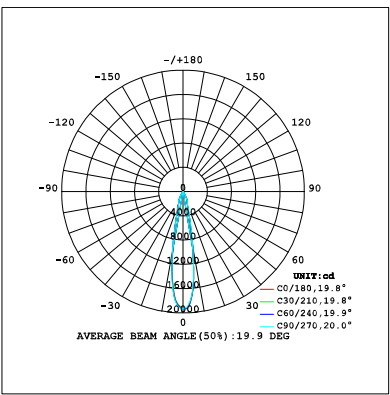

3000K

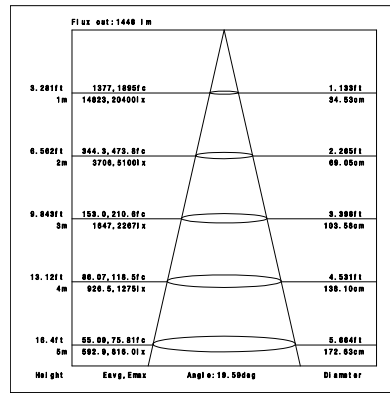

4000K

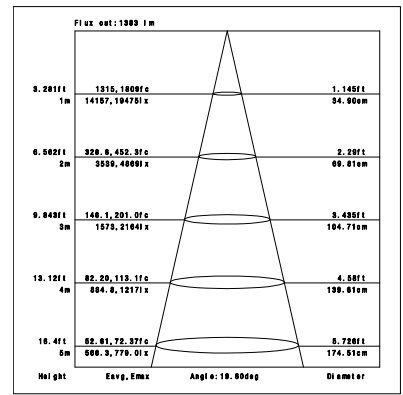

CRI90 45°

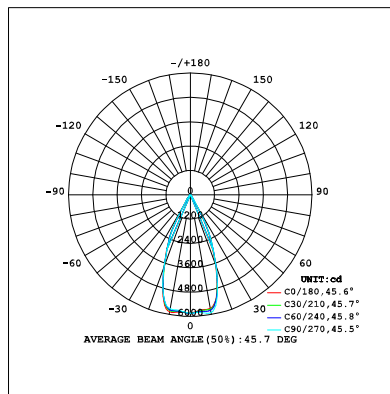

3000K

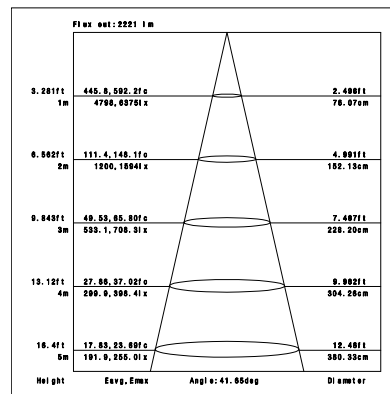

4000K

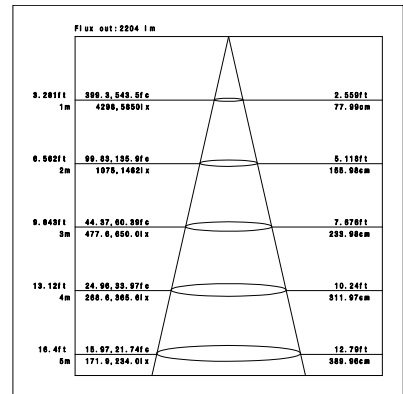

Packaging:

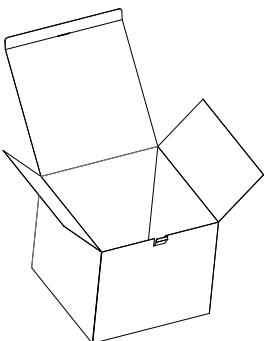

Box
 L245*W245*H220mm
 1pc/box
 GW: 1.95kg/box

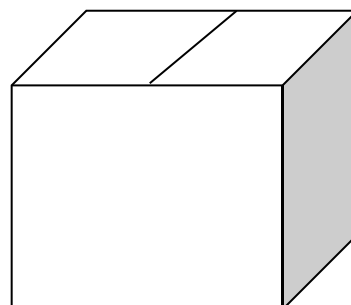

Outer carton
 L520xW520xH460mm
 8 pcs/CTN
 GW: 17kg/carton

Installation instruction

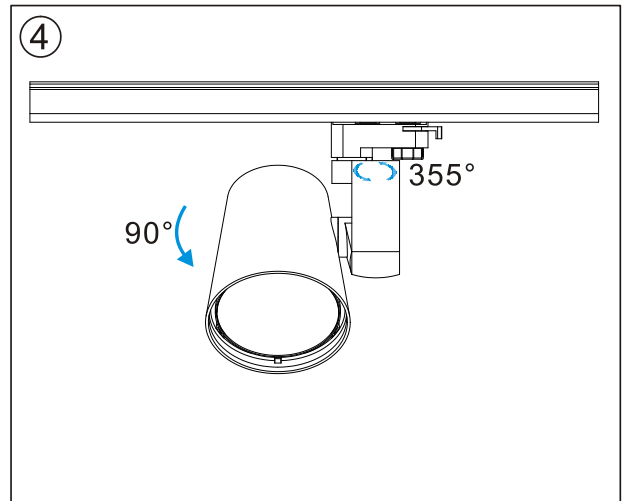
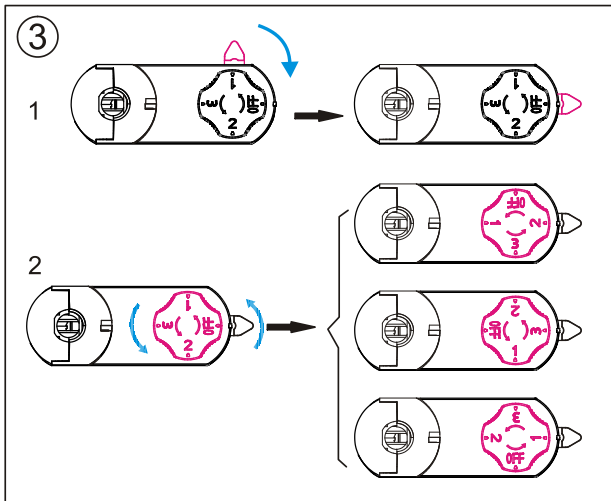
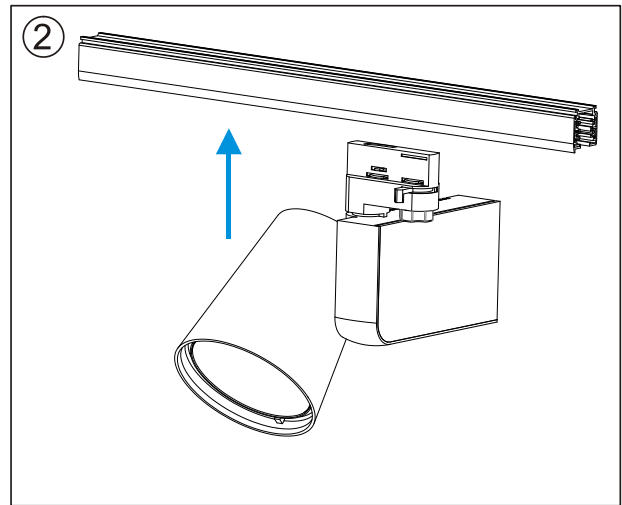
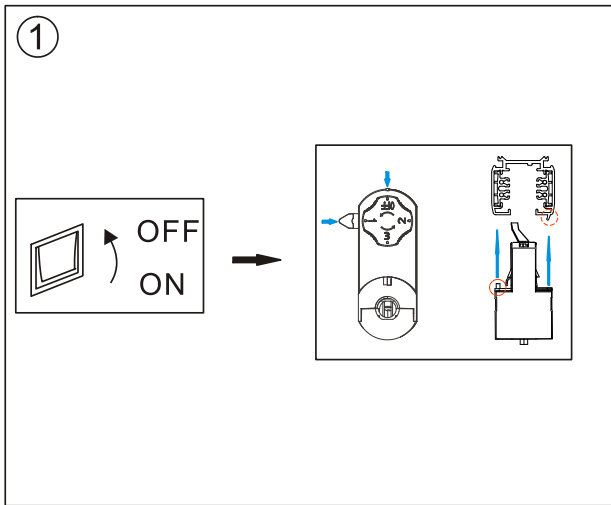

Cautions

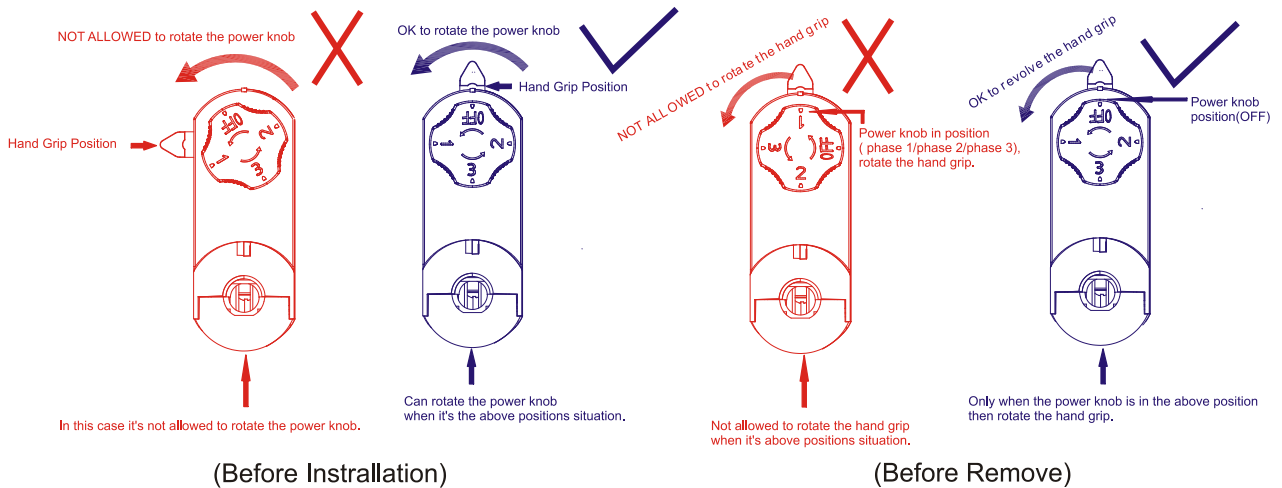

Product naming system

