

SD2-L328A/L646A /L964A

Technical Parameters:

Name	Parameters		
Light source:	3030SMD		
Input Voltage:	AC100~277V 50/60Hz		
Power	15W	30W	40W
LED Current:	350mA	700mA	1000mA
Rated life:	>50,000 hours		
Operating temperature:	-20°C~40°C		
Storage temperature:	-30°C~60°C		
Certificate:	CE/RoHS		
Dimmability:	Non-dimmable 0-10V dimming		
Weight:	0.8KG (L328)		
	1.4KG (L646)		
	2.0KG (L964)		

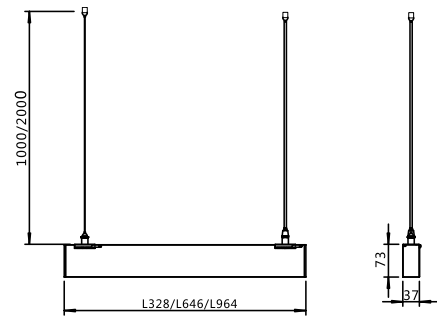
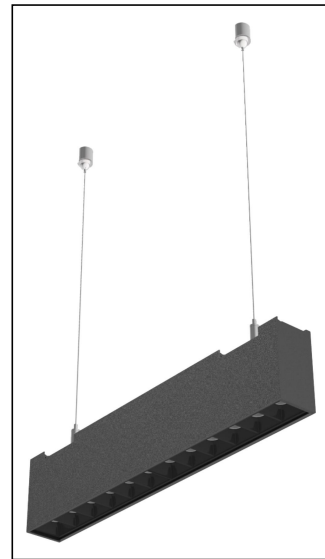

Ordering Information:

Length	Power	CRI	Beam Angle	Luminous	CCT	Housing	Part Number
328mm	15W	>80	15°/24°/36°/15x35°	1200 lm	2700K	○	SD2-L328A-15W-827-W-**
						●	SD2-L328A-15W-827-B-**
				1300 lm	3000K	○	SD2-L328A-15W-830-W-**
						●	SD2-L328A-15W-830-B-**
				1400 lm	4000K	○	SD2-L328A-15W-840-W-**
						●	SD2-L328A-15W-840-B-**
646mm	30W	>80	15°/24°/36°/15x35°	2300 lm	2700K	○	SD2-L646A-30W-827-W-**
						●	SD2-L646A-30W-827-B-**
				2400 lm	3000K	○	SD2-L646A-30W-830-W-**
						●	SD2-L646A-30W-830-B-**
				2450 lm	4000K	○	SD2-L646A-30W-840-W-**
						●	SD2-L646A-30W-840-B-**
964mm	40W	>80	15°/24°/36°/15x35°	3100 lm	2700K	○	SD2-L964A-40W-827-W-**
						●	SD2-L964A-40W-827-B-**
				3150 lm	3000K	○	SD2-L964A-40W-830-W-**
						●	SD2-L964A-40W-830-B-**
				3200 lm	4000K	○	SD2-L964A-40W-840-W-**
						●	SD2-L964A-40W-840-B-**

○ White ● Black

***: Angle 15/24/36/15x35



Technical Data test pattern

L328A

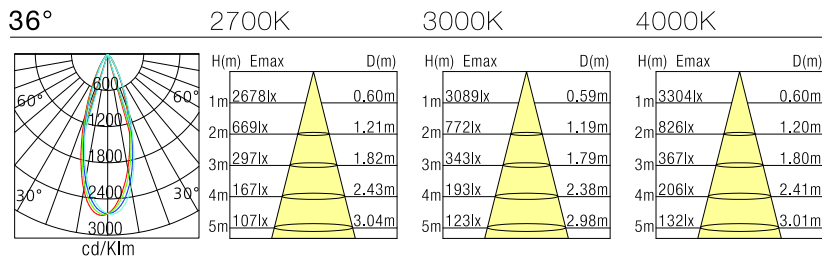
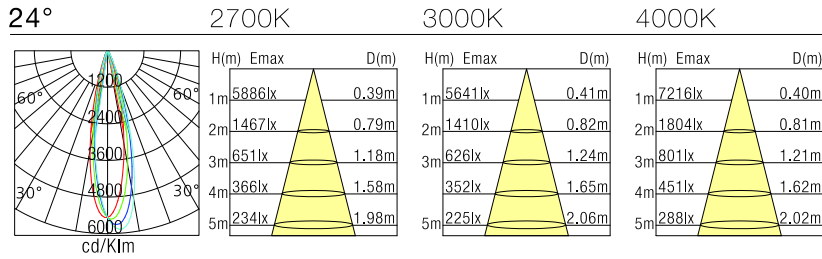
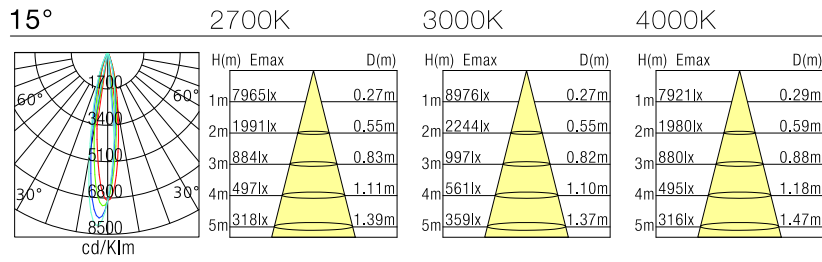

L646A

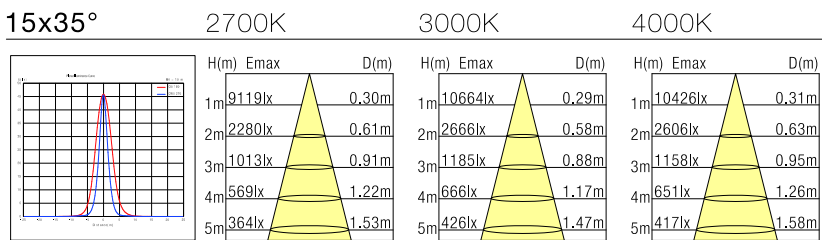
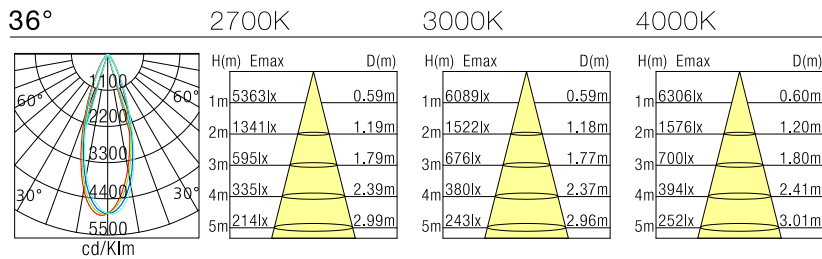
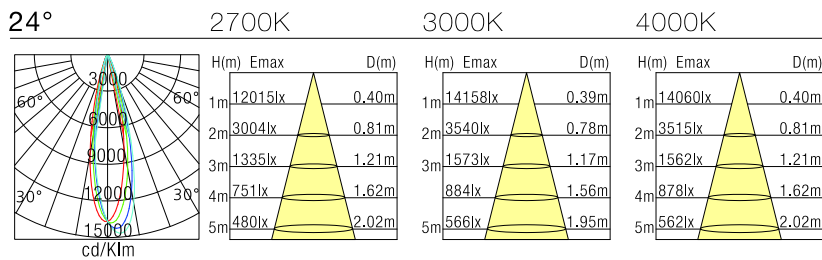

Installation instruction

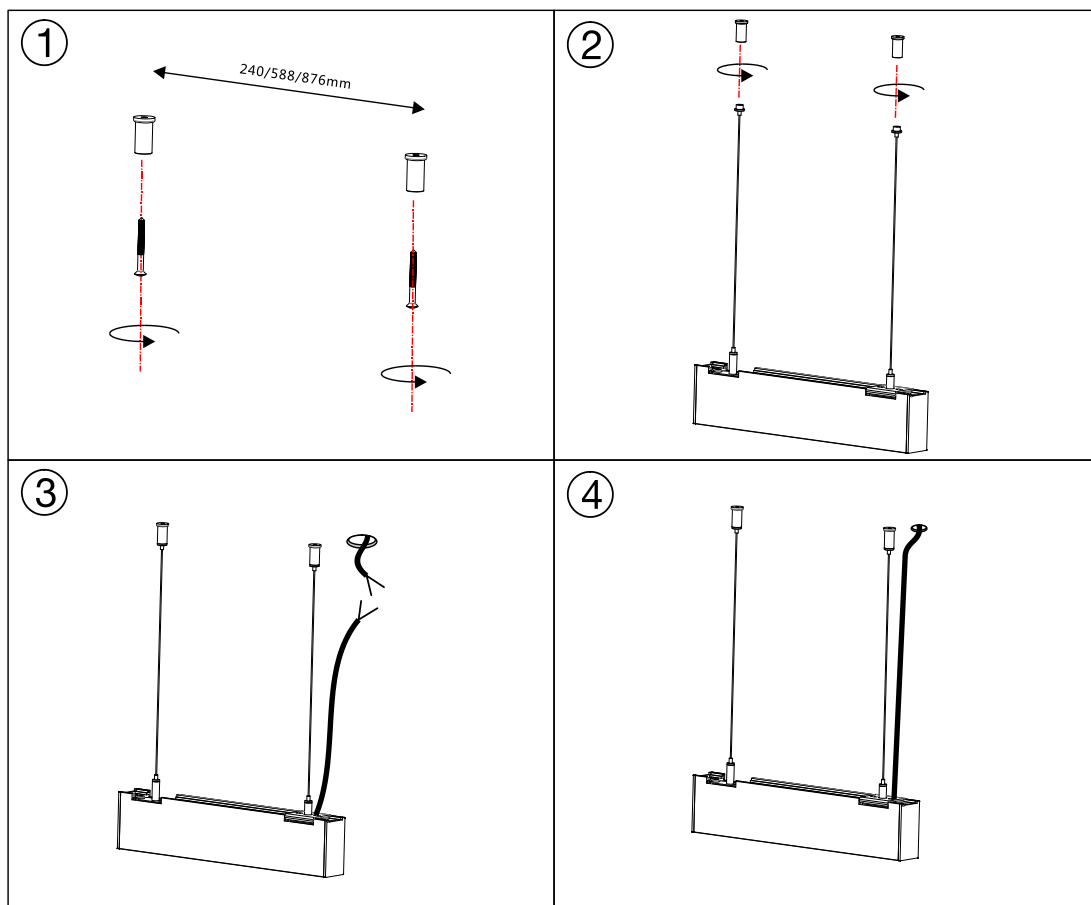

Packaging:

L328A

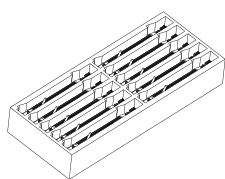

Inner Box

L690*W285*H110mm
10pc/box
GW: 8kg/box

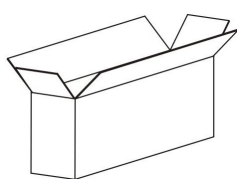

Master Carton

L700*295*265mm
20pc/box
GW: 17.2kg/box

L646A

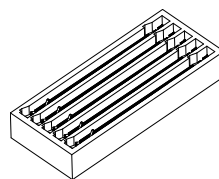

Inner Box

L690*W285*H110mm
5pc/box
GW: 7kg/box

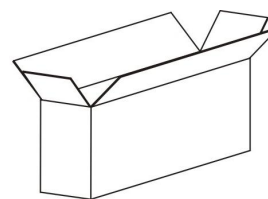

Master Carton

L700*295*265mm
10pc/box
GW: 15.2kg/box

L964A

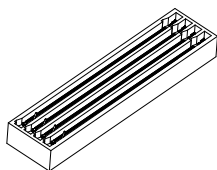

Inner Box

L995*W223*H110mm
4pc/box
GW: 8kg/box

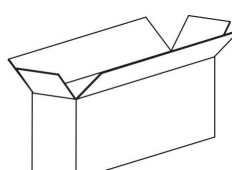

Master Carton

L1000*240*265mm
8pc/box
GW: 17.2kg/box

