

**SD1-L328B/L646B /L964B**

**Technical Parameters:**

Name	Parameters		
Light source:	2835SMD		
Input Voltage:	AC100~277V 50/60Hz		
Power	15W	30W	40W
LED Current:	350mA	700mA	1000mA
Rated life:	>50,000 hours		
Operating temperature:	-20°C~40°C		
Storage temperature:	-30°C~60°C		
Certificate:	CE/RoHS		
Dimmability:	Non-dimmable 0-10V dimming		
Weight:	0.8KG (L328) 1.4KG (L646) 2.0KG (L964)		

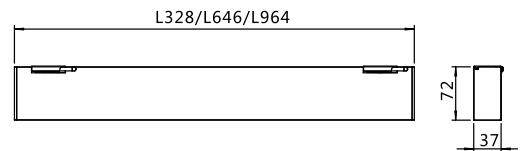

**Ordering Information:**

Length	Power	CRI	Beam Angle	Luminous	CCT	Housing	Part Number	
							○ White	● Black
328mm	15W	>80	90°	1100 lm	2700K	○	SD1-L328B-15W-827-W-90	
						●	SD1-L328B-15W-827-B-90	
				1150 lm	3000K	○	SD1-L328B-15W-830-W-90	
						●	SD1-L328B-15W-830-B-90	
				1200 lm	4000K	○	SD1-L328B-15W-840-W-90	
						●	SD1-L328B-15W-840-B-90	
646mm	30W	>80	90°	2200 lm	2700K	○	SD1-L646B-30W-827-W-90	
						●	SD1-L646B-30W-827-B-90	
				2235 lm	3000K	○	SD1-L646B-30W-830-W-90	
						●	SD1-L646B-30W-830-B-90	
				2230 lm	4000K	○	SD1-L646B-30W-840-W-90	
						●	SD1-L646B-30W-840-B-90	
964mm	40W	>80	90°	3050 lm	2700K	○	SD1-L964B-40W-827-W-90	
						●	SD1-L964B-40W-827-B-90	
				3100 lm	3000K	○	SD1-L964B-40W-830-W-90	
						●	SD1-L964B-40W-830-B-90	
				3150 lm	4000K	○	SD1-L964B-40W-840-W-90	
						●	SD1-L964B-40W-840-B-90	



Technical Data test pattern

**15W, 3000K, CRI80**

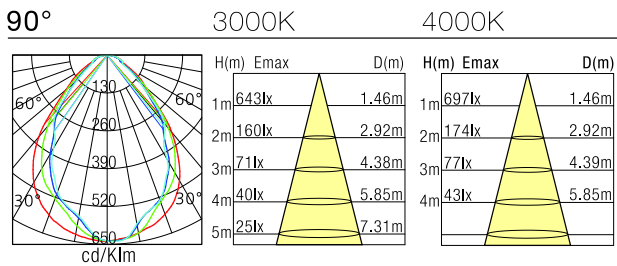

**30W, 3000K, CRI80**

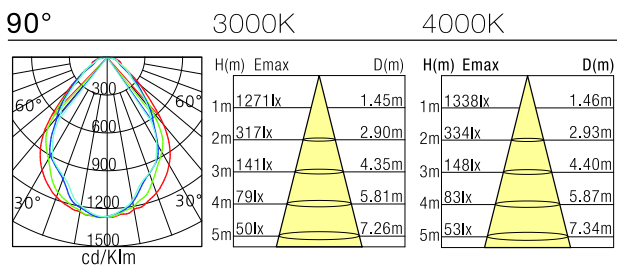

Installation instruction

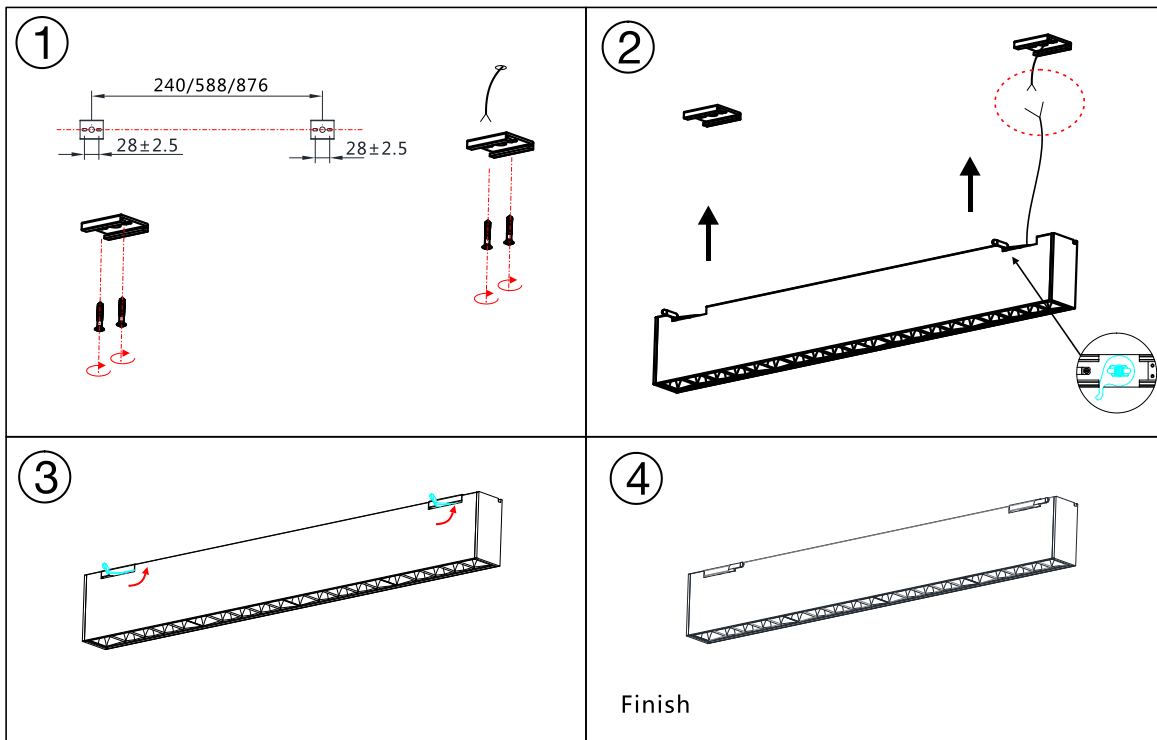

Packaging:

**L328B**

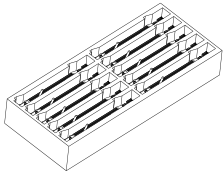

**Inner Box**

L690\*W285\*H110mm

10pc/box

GW: 8kg/box

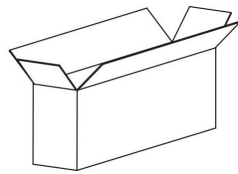

**Master Carton**

L700\*295\*265mm

20pc/box

GW: 17.2kg/box

**L646B**

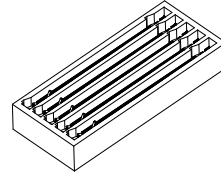

**Inner Box**

L690\*W285\*H110mm

5pc/box

GW: 7kg/box

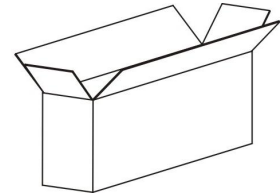

**Master Carton**

L700\*295\*265mm

10pc/box

GW: 15.2kg/box

**L964B**

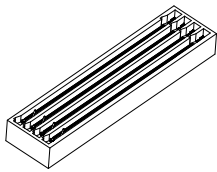

**Inner Box**

L995\*W223\*H110mm

4pc/box

GW: 8kg/box

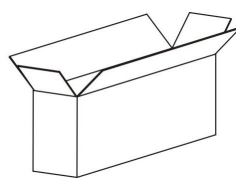

**Master Carton**

L1000\*240\*265mm

8pc/box

GW: 17.2kg/box

