

Halolite Series

M042-15W

Reflector



Technical Parameters:

Name	Parameters
Light source:	COB
Input Voltage:	AC220~240V 50/60Hz
Current:	350mA
Rated life:	>50,000 hours
Operating temperature:	-20°C~40°C
Storage temperature:	-30°C~60°C
Certificate:	CE/RoHS
Dimmability:	Dimmable Optional
Weight:	0.3KG

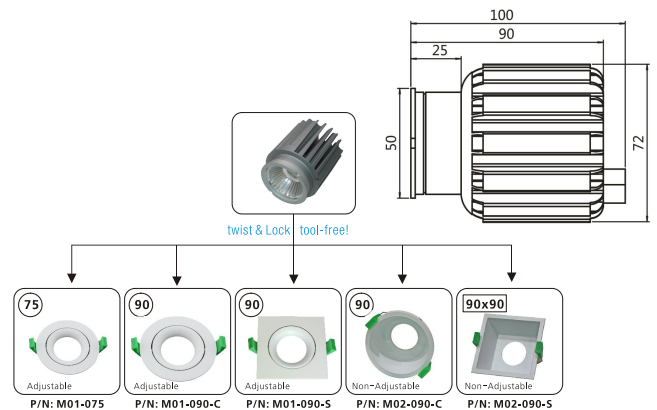

Ordering Information:

Power	CRI	Beam Angle	Luminous	CCT	Housing	Part Number
15W	>80	▲ 15°	1625 lm	3000K	○	M042*-15W-830-S-15
			1675 lm	4000K	○	M042*-15W-840-S-15
		▲ 24°	1595 lm	3000K	○	M042*-15W-830-S-24
			1640 lm	4000K	○	M042*-15W-840-S-24
		▲ 38°	1605 lm	3000K	○	M042*-15W-830-S-38
			1650 lm	4000K	○	M042*-15W-840-S-38
	▲ 60°	1610 lm	3000K	○	M042*-15W-830-S-60	
		1665 lm	4000K	○	M042*-15W-840-S-60	
	>90	▲ 15°	1340 lm	3000K	○	M042*-15W-930-S-15
			1430 lm	4000K	○	M042*-15W-940-S-15
		▲ 24°	1320 lm	3000K	○	M042*-15W-930-S-24
			1435 lm	4000K	○	M042*-15W-940-S-24
▲ 38°		1330 lm	3000K	○	M042*-15W-930-S-38	
		1440 lm	4000K	○	M042*-15W-940-S-38	
▲ 60°	1340 lm	3000K	○	M042*-15W-930-S-60		
	1460 lm	4000K	○	M042*-15W-940-S-60		

○ Silver gray

**": 1: S-MR16; 2: M01-075; 3: M01-090-C; 4: M01-090-S; 5: M02-090-C; 6: M02-090-S

Technical Data test pattern

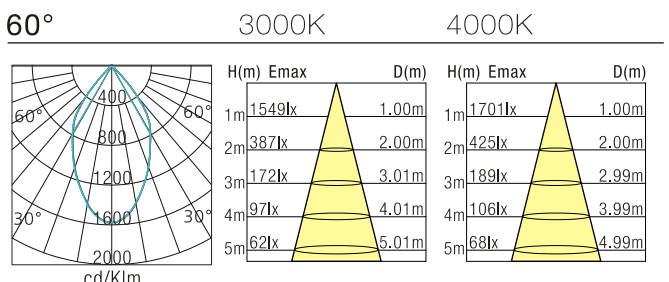
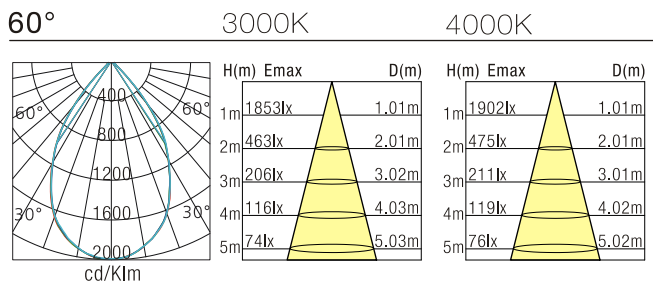
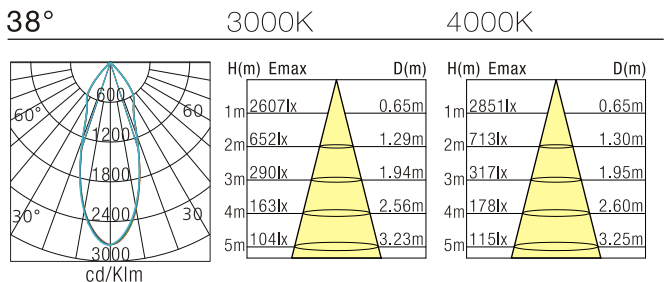
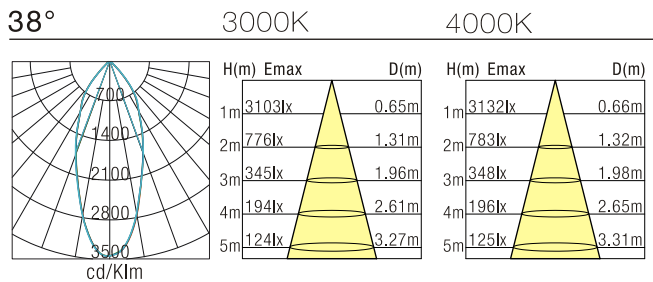
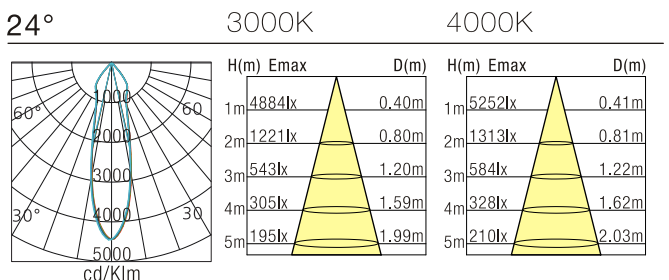
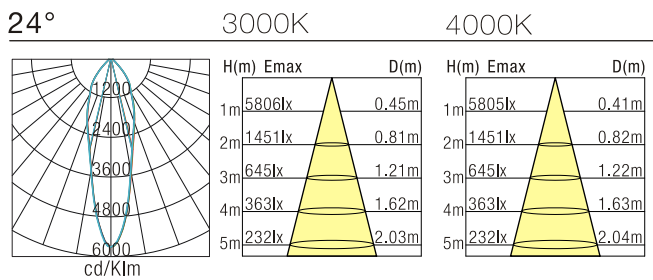
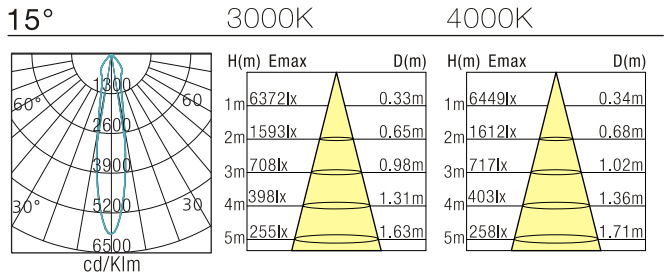
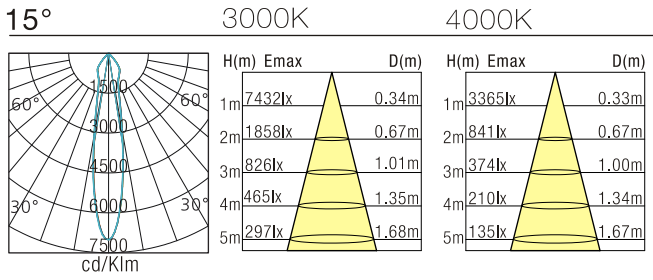

Installation instruction

M04 Module + M01-090-C/S Installation

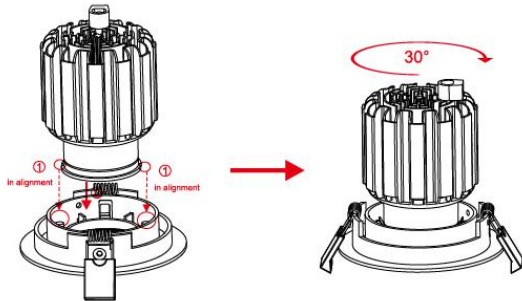

M04 Module + M02-090-C Installation

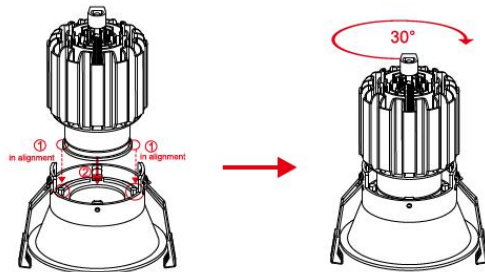

M04 Module + M02-090-S Installation

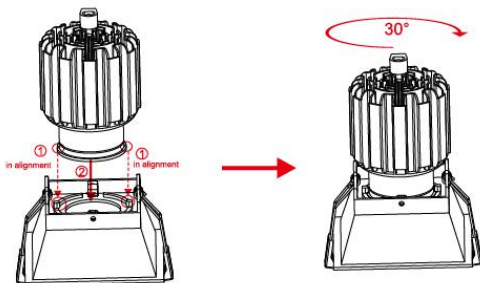

1, Cut Hole



2, Connect Wire

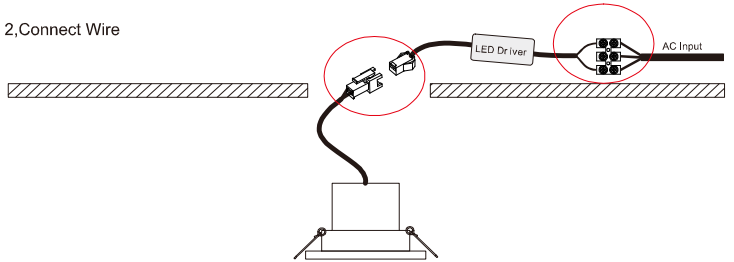

3, Fit the luminaire in the hole

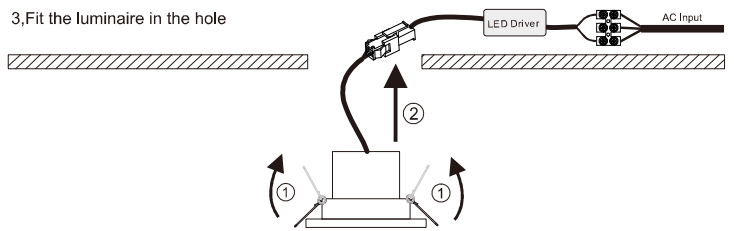

4, Finish

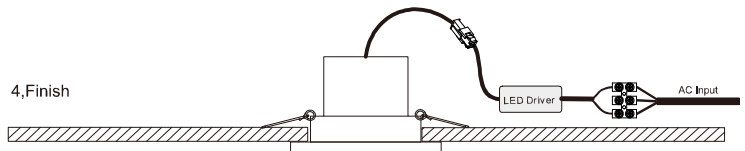

Packaging:

M042 (Without driver)

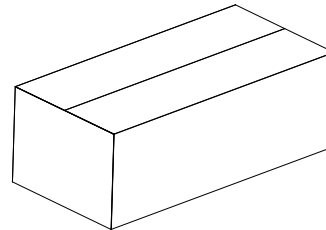
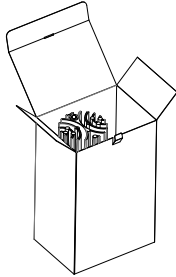

Box
 L105*W105*H125mm
 1pc/box
 GW: 0.4kg/box

Outer carton
 L430*W430*H390mm
 48pcs/CTN
 GW: 20.2kg/carton

Product Nomenclature

