

Halolite Series

M02-9W

Reflector

Technical Parameters:

Name	Parameters
Light source:	COB
Input Voltage:	AC220~240V 50/60Hz
LED Current:	200mA (37V)
Rated life:	>50,000 hours
Operating temperature:	-20°C~40°C
Storage temperature:	-30°C~60°C
Certificate:	CE/RoHS
Dimmability:	Dimmable Optional
Weight:	0.10KG (M021) / 0.15KG (M0212) 0.19KG (M0213) / 0.20KG (M0214) 0.20KG (M0215) / 0.22KG (M0216)

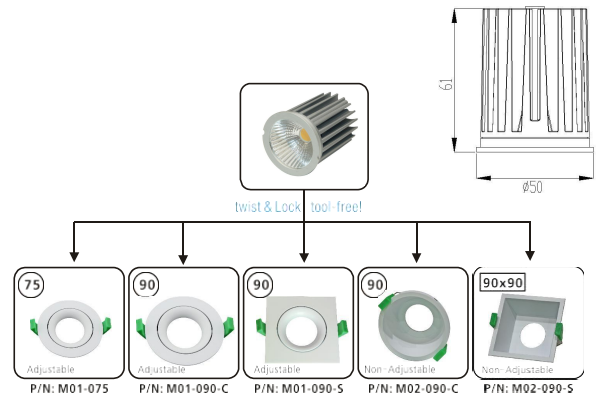

Ordering Information:

○ Silver gray

Power	CRI	Beam Angle	Luminous	CCT	Housing	Part Number	
9W	82	16°	930 lm	3000K	○	M021*-9W-830-S-16	
			950 lm	4000K	○	M021*-9W-840-S-16	
		▲ 28°	920 lm	3000K	○	M021*-9W-830-S-28	
			930 lm	4000K	○	M021*-9W-840-S-28	
		▲ 40°	930 lm	3000K	○	M021*-9W-830-S-40	
			950 lm	4000K	○	M021*-9W-840-S-40	
		>90	▲ 60°	930 lm	3000K	○	M021*-9W-830-S-60
			940 lm	4000K	○	M021*-9W-840-S-60	
	▲ 16°		770 lm	3000K	○	M021*-9W-930-S-16	
			860 lm	4000K	○	M021*-9W-940-S-16	
	▲ 28°		750 lm	3000K	○	M021*-9W-930-S-28	
			850 lm	4000K	○	M021*-9W-940-S-28	
		▲ 40°	770 lm	3000K	○	M021*-9W-930-S-40	
			860 lm	4000K	○	M021*-9W-940-S-40	
		▲ 60°	760 lm	3000K	○	M021*-9W-930-S-60	
			870 lm	4000K	○	M021*-9W-940-S-60	

***: 1: S-MR16; 2: M01-075; 3: M01-090-C; 4: M01-090-S; 5: M02-090-C; 6: M02-090-S

Technical Data test pattern

CRI82 16°

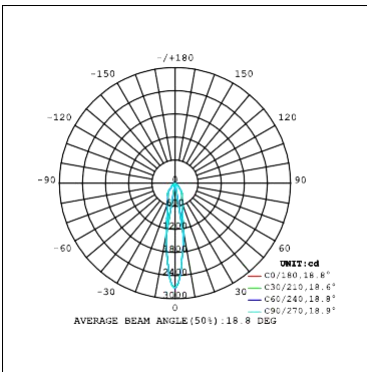

3000K

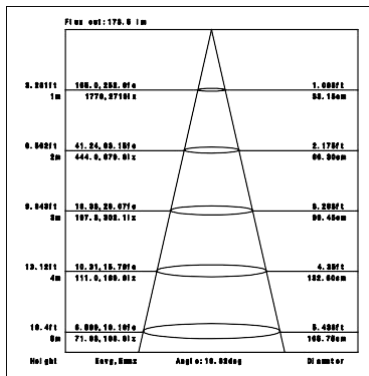

4000K

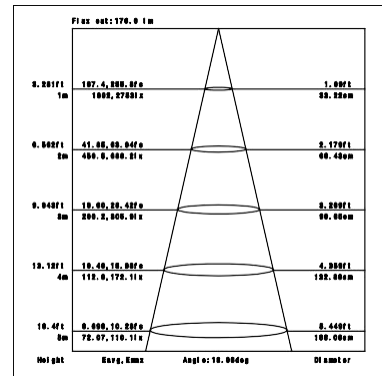

CRI82 28°

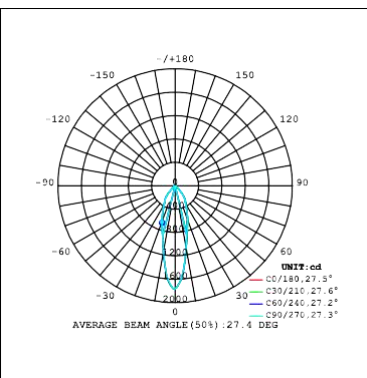

3000K

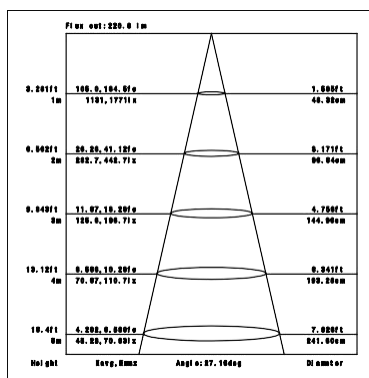

4000K

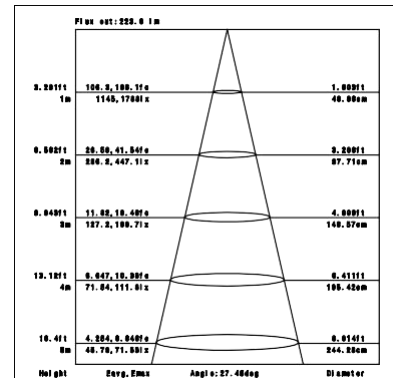

CRI82 40°

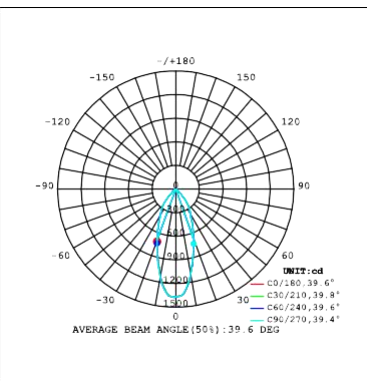

3000K

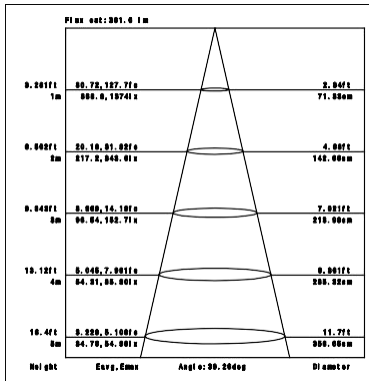

4000K

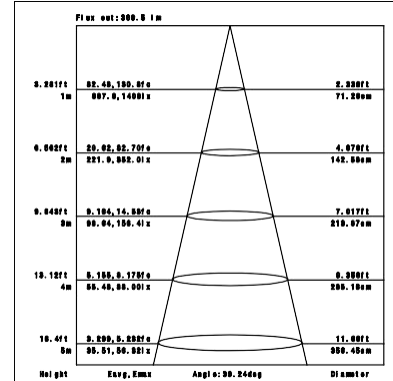

CRI82 60°

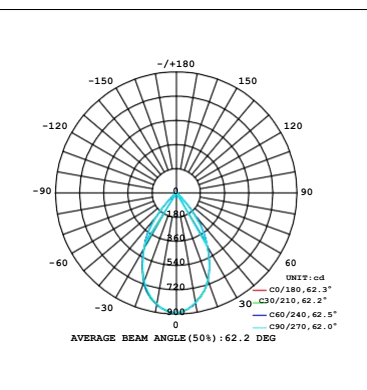

3000K

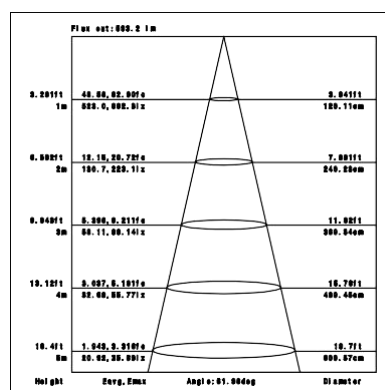

4000K

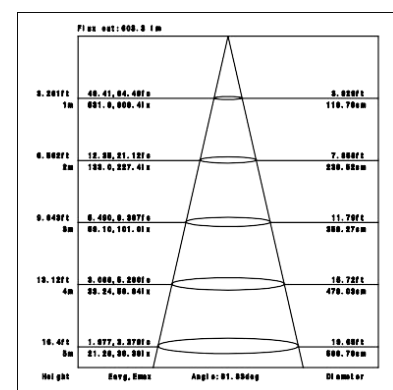

CRI90 16°

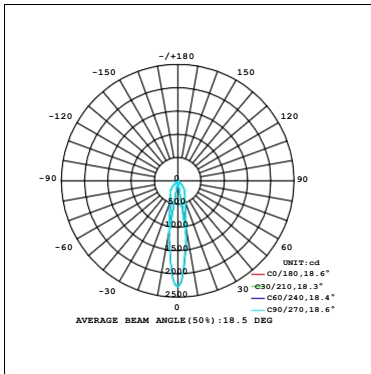

3000K

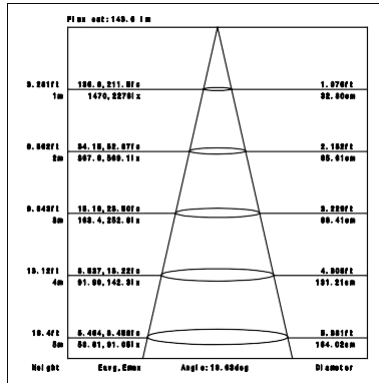

4000K

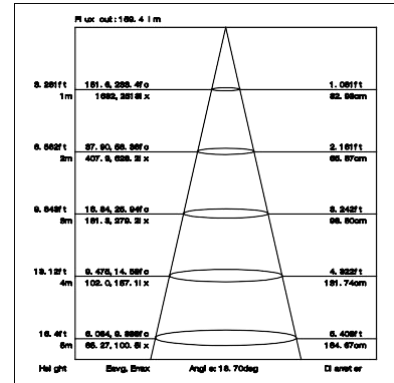

CRI90 28°

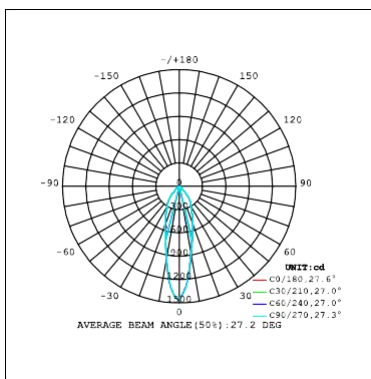

3000K

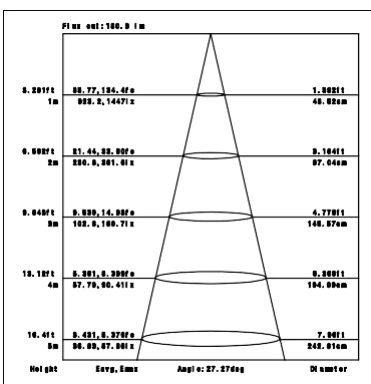

4000K

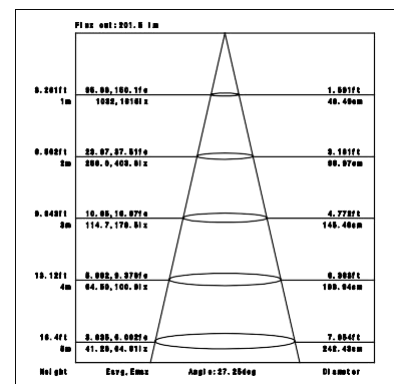

CRI90 40°

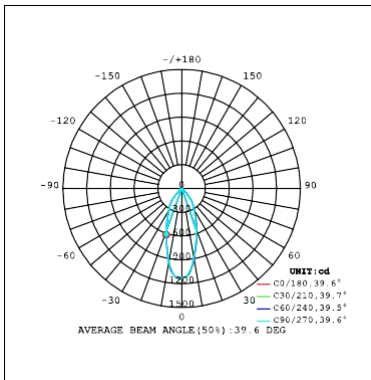

3000K

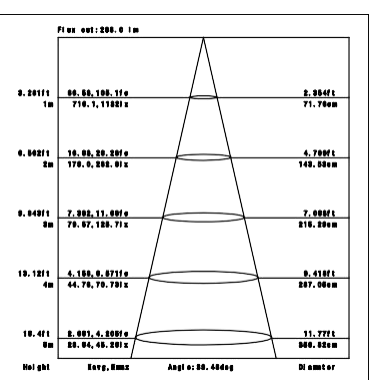

4000K

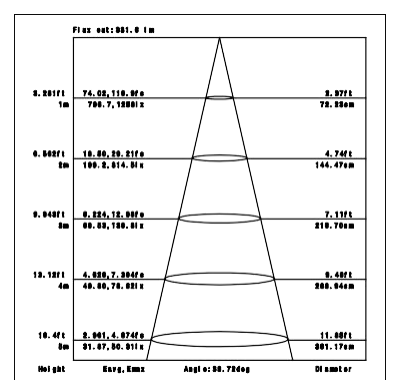

CRI90 60°

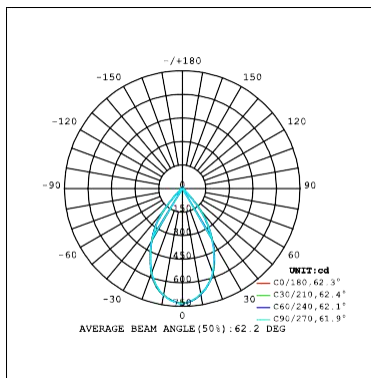

3000K

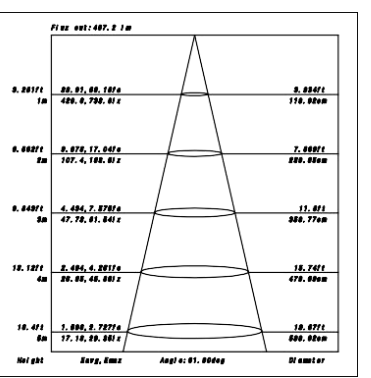

4000K

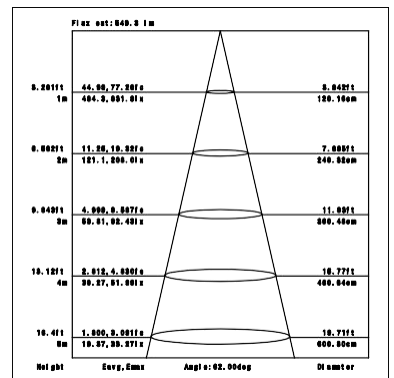

Installation instruction

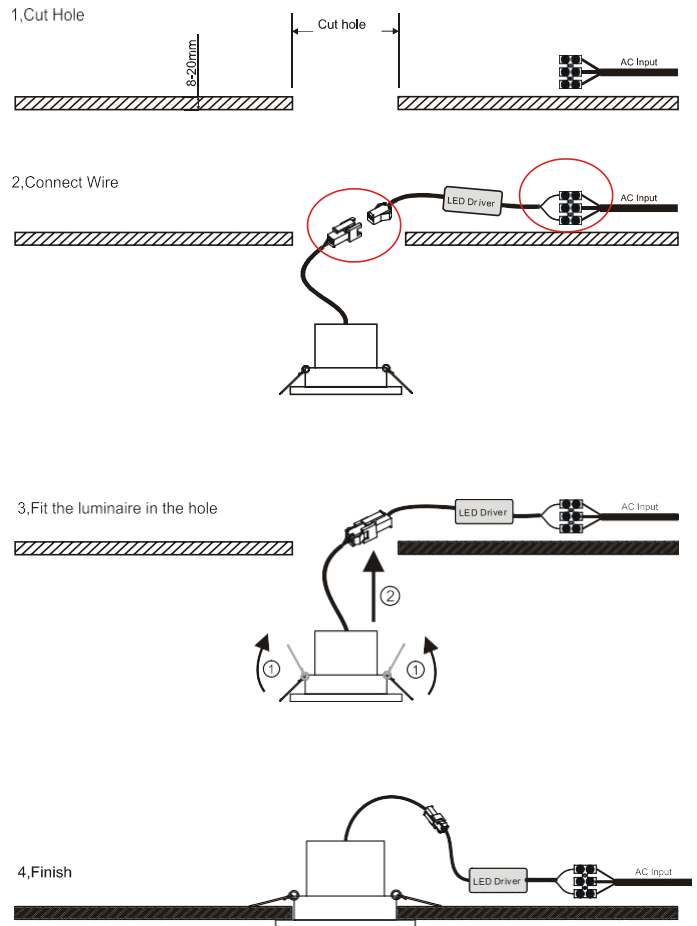
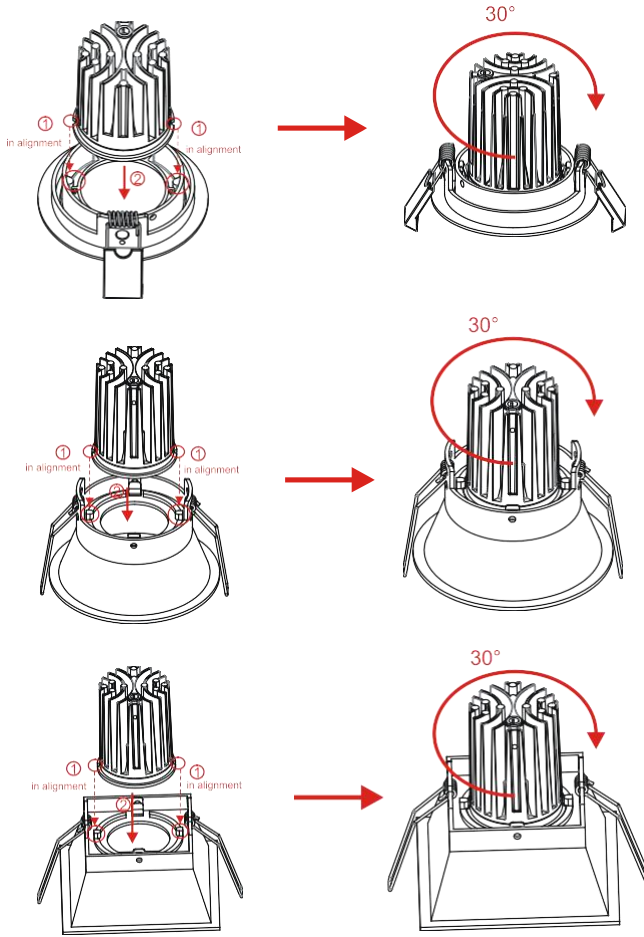

Packaging:

M021 (Without driver)

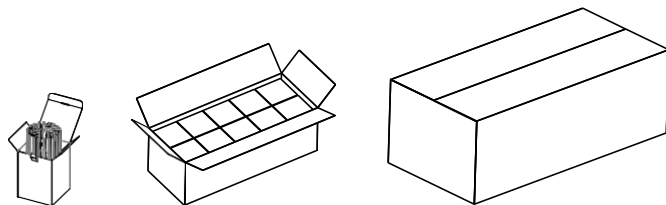

Box L52*W52*H76mm 1pc/box GW: 0.1kg/box	Inner box L270*W110*H95mm 10pc/box GW: 1.3kg/box	Outer carton L600*W300*H230mm 100pcs/CTN GW: 14kg/carton
---	--	--

M021 (With driver)

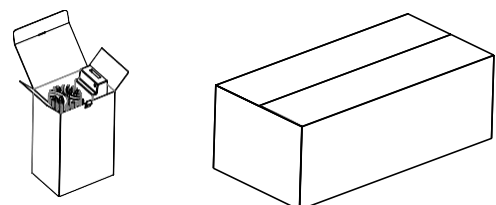

Box L96*W65*H140mm 1pc/box GW: 0.2kg/box	Outer carton L600*W300*H230mm 36pcs/CTN GW: 8.5kg/carton
--	--

M0212

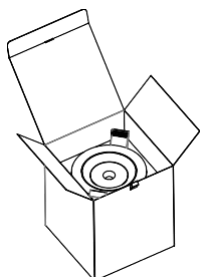

Box

L105*W105*H130mm

1pc/box

GW: 0.3kg/box

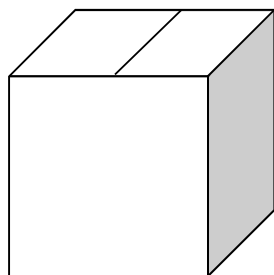

Outer carton

L450*W450*H410mm

48pcs/CTN

GW: 16kg/carton

M0213

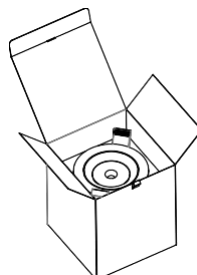

Box

L105*W105*H130mm

1pc/box

GW: 0.3kg/box

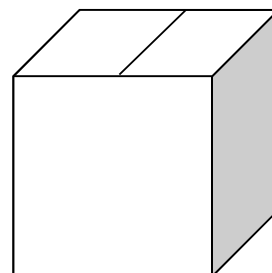

Outer carton

L450*W450*H410mm

48pcs/CTN

GW: 16kg/carton

M0214/M0216

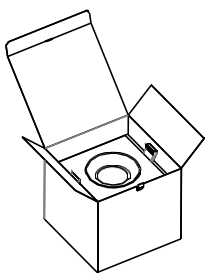

Box

L130*W130*H120mm

1pc/box

GW: 0.35kg/box

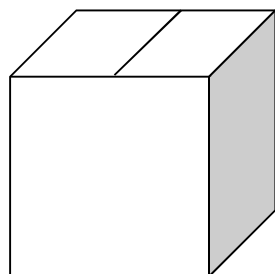

Outer carton

L540*W420*H280mm

24pcs/CTN

GW: 9.5kg/carton

M0215

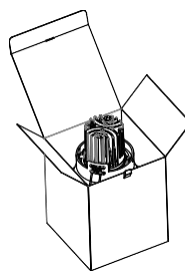

Box

L105*W105*H130mm

1pc/box

GW: 0.35kg/box

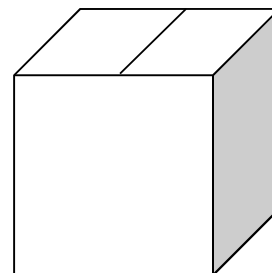

Outer carton

L450*W450*H410mm

48pcs/CTN

GW: 18.5kg/carton

Product naming system

