

veraLite Series

**DL18-40W**

Reflector

Technical Parameters:

Name	Parameters
Light source:	COB
Input Voltage:	AC220~240V 50/60Hz
LED Current:	1000mA (35-37V)
Rated life:	>50,000 hours
Operating temperature:	-20°C~40°C
Storage temperature:	-30°C~60°C
Certificate:	TUV/CE/RoHS
Dimmability:	Dimmable Optional
Weight:	1.1KG

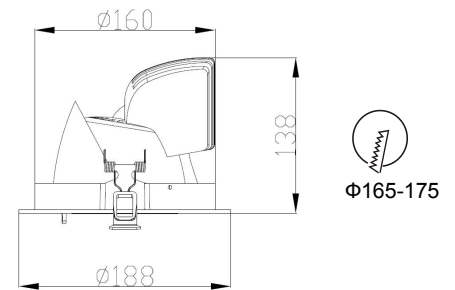
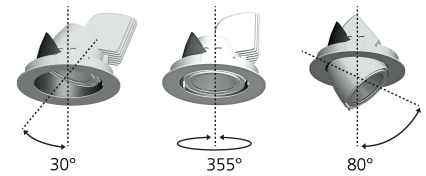

Ordering Information:

○White

Power	CRI	Beam Angle	Luminous	CCT	Housing	Part Number
40W	>80	▲ 15°	4330 lm	3000K	○	DL181-40W-830-W-15
			4390 lm	4000K	○	DL181-40W-840-W-15
		▲ 20°	4370 lm	3000K	○	DL181-40W-830-W-20
			4500 lm	4000K	○	DL181-40W-840-W-20
		▲ 45°	4340 lm	3000K	○	DL181-40W-830-W-45
			4570 lm	4000K	○	DL181-40W-840-W-45
	>90	▲ 15°	3630 lm	3000K	○	DL181-40W-930-W-15
			3750 lm	4000K	○	DL181-40W-940-W-15
		▲ 20°	3790 lm	3000K	○	DL181-40W-930-W-20
			3830 lm	4000K	○	DL181-40W-940-W-20
		▲ 45°	3760 lm	3000K	○	DL181-40W-930-W-45
			3890 lm	4000K	○	DL181-40W-940-W-45

Technical Data test pattern

CRI80 15°

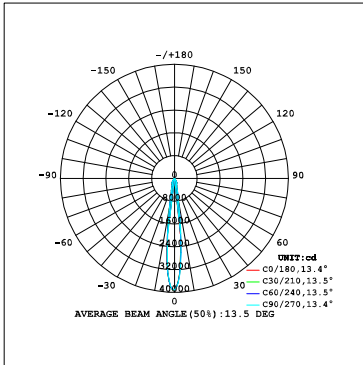

3000K

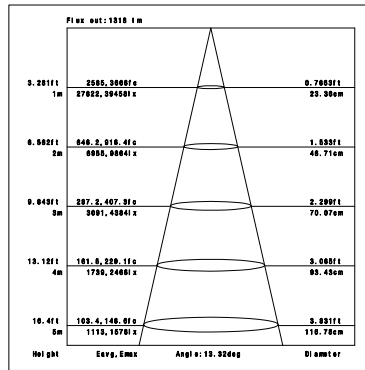

4000K

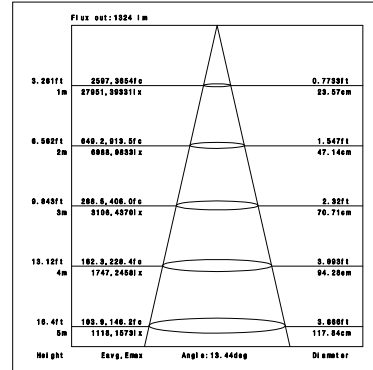

CRI80 20°

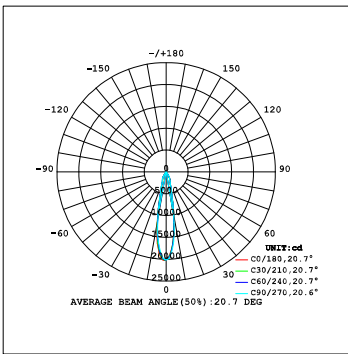

3000K

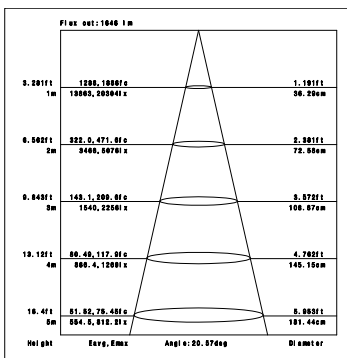

4000K

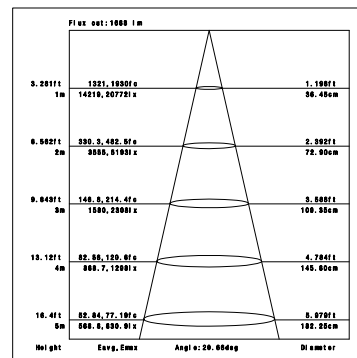

CRI80 45°

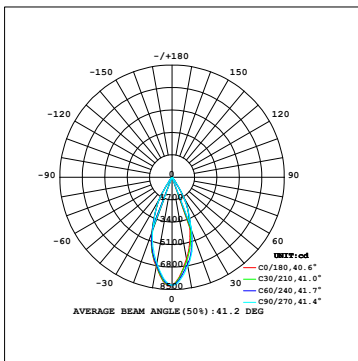

3000K

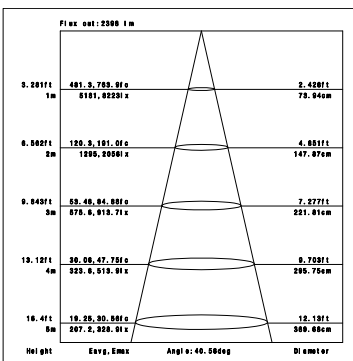

4000K

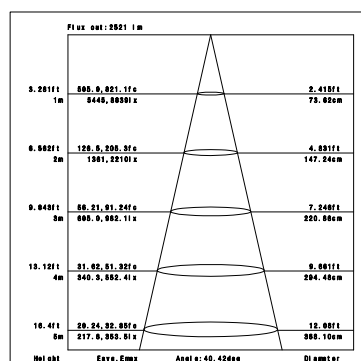

CRI90 15°

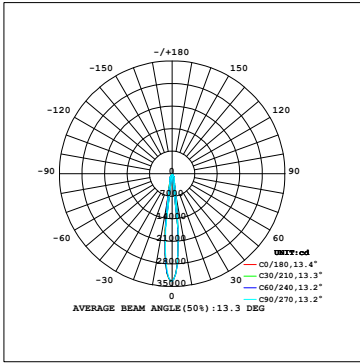

3000K

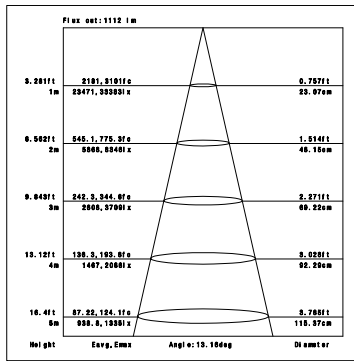

4000K

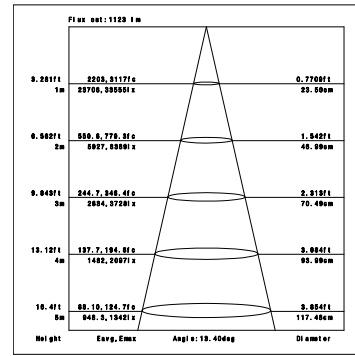

CRI90 20°

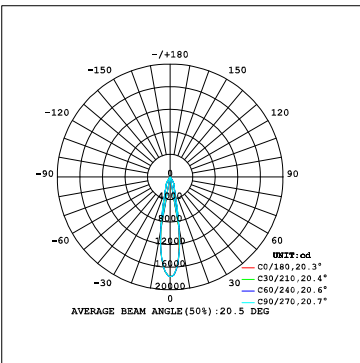

3000K

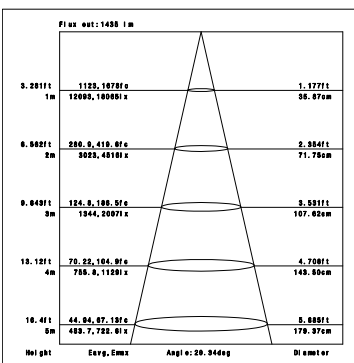

4000K

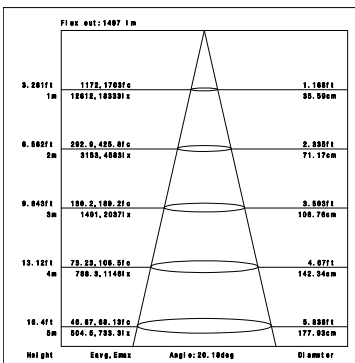

CRI90 45°

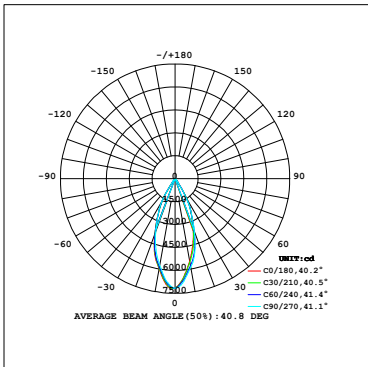

3000K

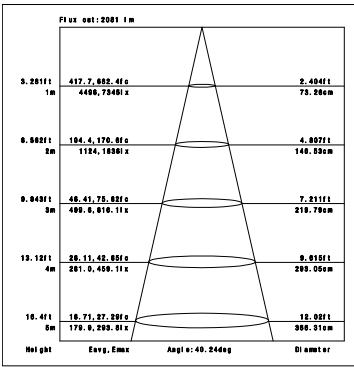

4000K

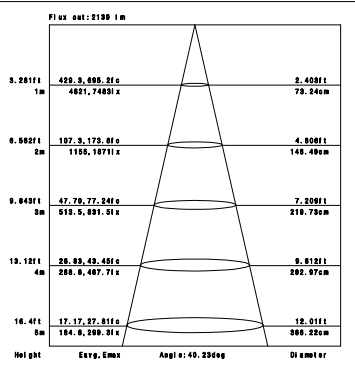

Packaging:

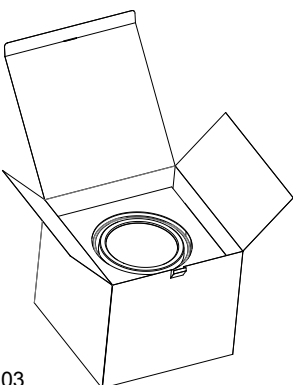

Box  
L230\*W230\*H220mm  
1pc/box  
GW: 1.55kg/box

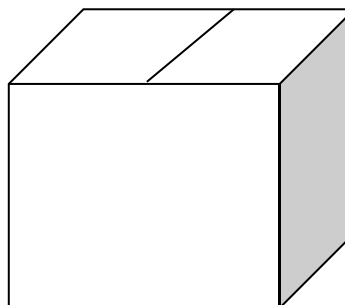

Outer carton  
L480xW480xH470mm  
8pcs/CTN  
GW: 13kg/carton

Installation instruction

1, Cut Hole

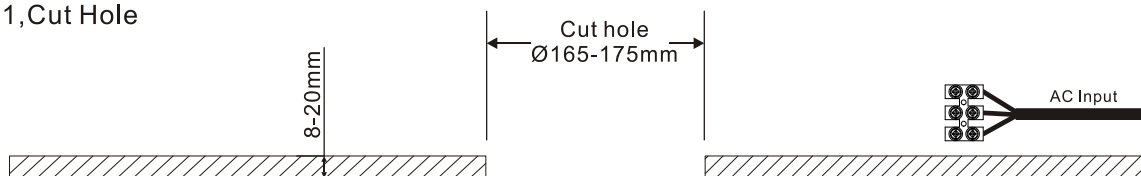

2, Connect Wire

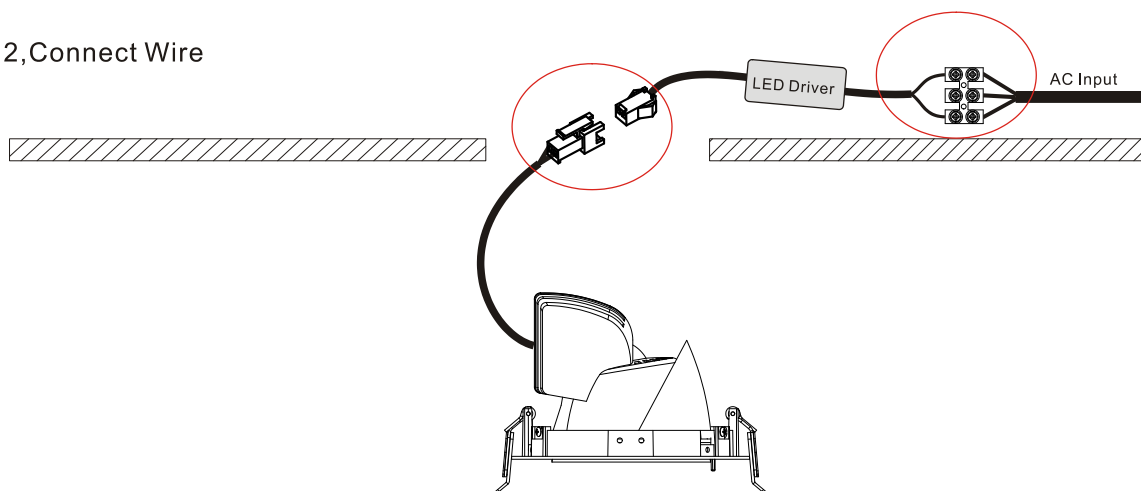

3, Fit the luminaire in the hole

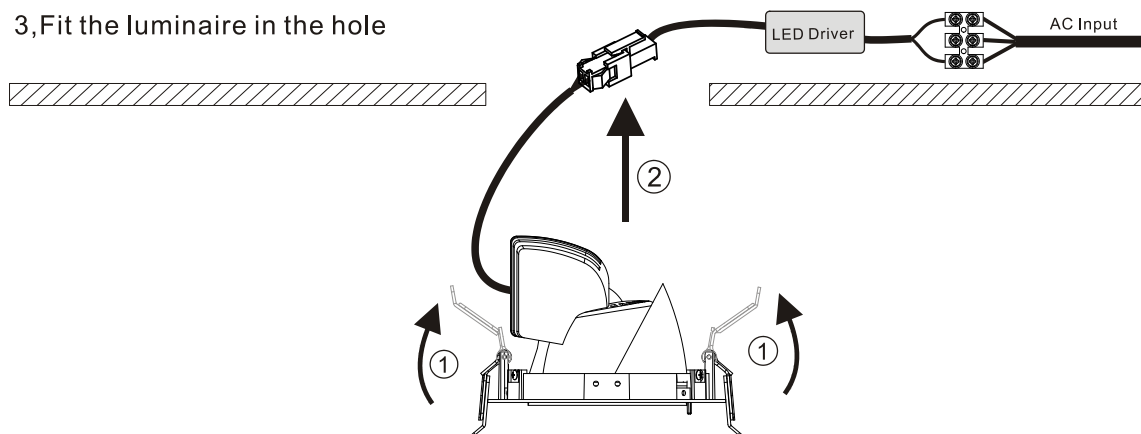

4, Finish

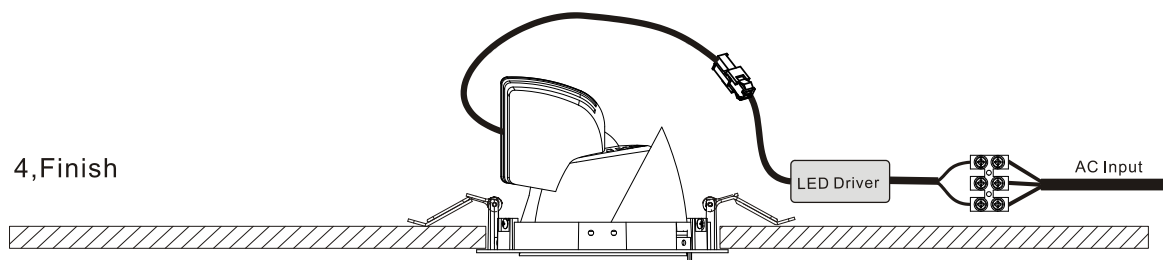

Product naming system

**DL ( X ) XX X (H) – XW – X XX – X- XX**

