

DL18 Installation Instruction

1, Cut Hole

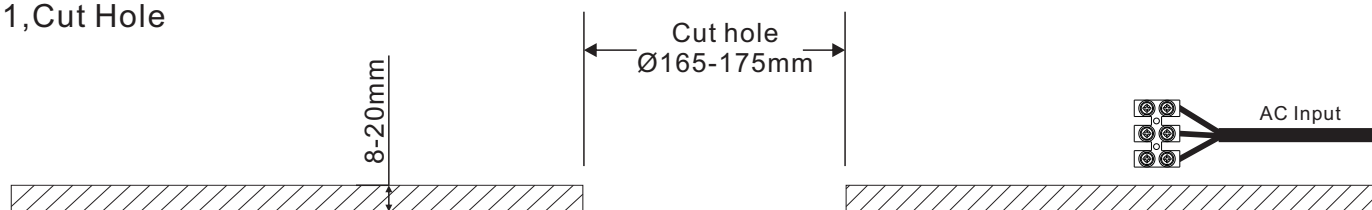

2, Connect Wire

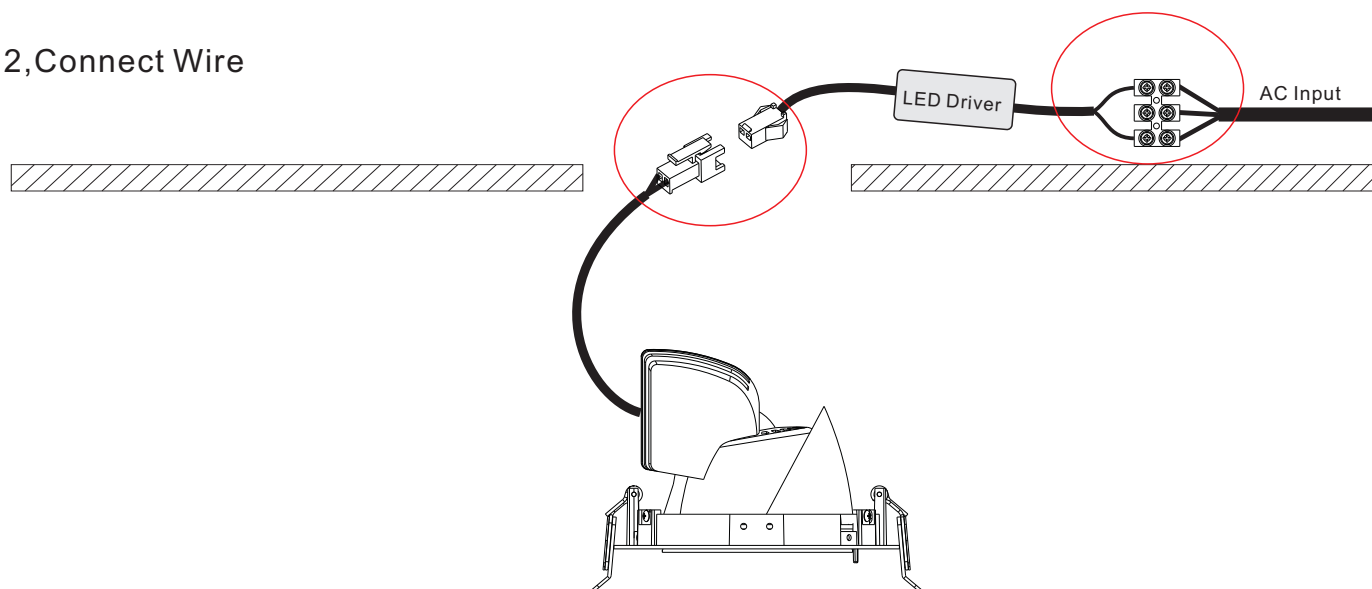

3, Fit the luminaire in the hole

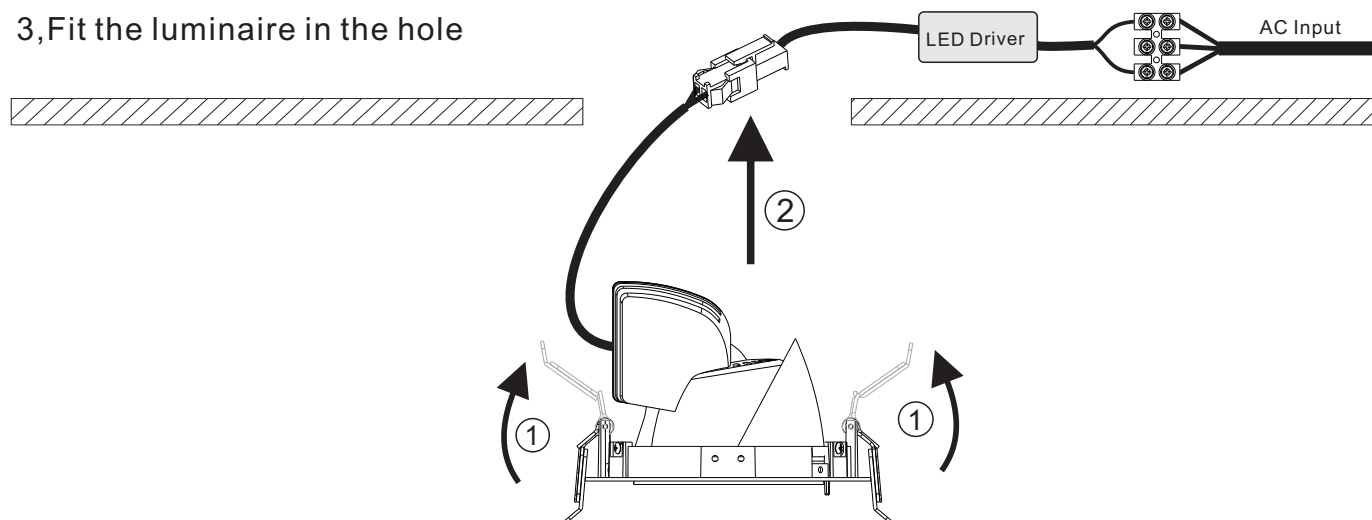

4, Finish

